

Operation Manual Multi-parameter Transmitter M200



Operation Manual Multi-parameter Transmitter M200

Content

1	Introduction	7
2	Safety instructions	7
2.1	Definition of Equipment and Documentation Symbols and Designations	7
2.2	Correct Disposal of the Unit	8
3	Unit Overview	9
3.1	Overview 1/4DIN	9
3.2	Overview 1/2DIN	9
3.3	Control/Navigation Keys	10
3.3.1	Menu Structure	10
3.3.2	Navigation Keys	10
3.3.2.1	Navigating the Menu Tree	10
3.3.2.2	Escape	11
3.3.2.3	Enter	11
3.3.2.4	Menu	11
3.3.2.5	Calibration Mode	11
3.3.2.6	Info Mode	11
3.3.3	Navigation of Data Entry Fields	11
3.3.4	Entry of Data Values, Selection of Data Entry Options	11
3.3.5	Navigation with ↑ in Display	12
3.3.6	"Save changes" Dialog	12
3.3.7	Security Passwords	12
3.4	Display	12
4	Installation instruction	13
4.1	Unpacking and Inspection of Equipment	13
4.2	Installation – 1/4DIN Models	13
4.2.1	1/4DIN Version – Dimension Drawings	13
4.2.2	Installation Procedure – 1/4DIN Models	14
4.3	Installation – 1/2DIN Models	15
4.3.1	1/2DIN Version – Dimension Drawings	15
4.3.2	1/2DIN Version – Pipe Mounting	15
4.3.3	Installation Procedure – 1/2DIN Models	16
4.4	Connection of Power Supply	18
4.4.1	1/4DIN Housing (Panel Mount)	18
4.4.2	1/2DIN Housing (Wall Mount)	19
4.5	Connector Terminal Definition	20
4.5.1	TB1 and TB2 for 1/2DIN and 1/4DIN Versions	20
4.5.2	TB3/TB4* – pH, ORP, Dissolved Oxygen, Ozone and 4-Electrode Conductivity Sensor	20
4.5.3	TB3/TB4 – 2-electrode Conductivity Sensor	21
4.6	Assembling of Sensor and Cable	22
4.6.1	Connection of Sensors for pH, ORP, Dissolved Oxygen, Ozone and 4-electrode Conductivity	22
4.6.2	AK9 Cable Assignment	22
5	Placing transmitter in, or Out of Service	23
5.1	Placing Transmitter in Service	23
5.2	Placing Transmitter Out of Service	23
6	Quick Setup	24
7	Sensor Calibration	25
7.1	Enter Calibration Mode	25
7.2	Conductivity/Resistivity Calibration	25
7.2.1	One-point Sensor Calibration	26
7.2.2	Two-point Sensor Calibration (4-electrode Sensors only)	26
7.2.3	Process Calibration	27
7.3	Oxygen Calibration	28
7.3.1	One-Point Sensor Calibration	28
7.3.2	Process Calibration	28
7.4	pH Calibration	29
7.4.1	One-Point Calibration	29
7.4.1.1	Auto Mode	29
7.4.1.2	Manual mode	30
7.4.2	Two-Point Calibration	30
7.4.2.1	Auto Mode	30
7.4.2.2	Manual Mode	31
7.4.3	Process Calibration	31
7.5	ORP Calibration	32
7.5.1	One-Point Calibration	32

7.6	Ozone Calibration	32
7.6.1	One-Point ZeroPt Calibration	32
7.6.2	Process Calibration	33
7.7	Sensor Verification	33
8	Configuration	34
8.1	Enter Configuration Mode	34
8.2	Measurement	34
8.2.1	Channel Setup	34
8.2.2	Derived Measurements	35
8.2.2.1	% Rejection measurement	35
8.2.2.2	Calculated pH (Power Plant Applications only)	36
8.2.2.3	Calculated CO ₂ (Power Plant Applications only)	36
8.2.3	Parameter Related Settings	36
8.2.3.1	Conductivity/Temperature Compensation	37
8.2.3.2	pH Parameters	38
8.2.3.3	Dissolved Oxygen Parameters	38
8.2.4	Set Averaging	39
8.3	Analog Outputs	40
8.4	Setpoints	41
8.5	Alarm/Clean	42
8.5.1	Alarm	42
8.5.2	Clean	43
8.6	Display	43
8.6.1	Measurement	43
8.6.2	Resolution	44
8.6.3	Backlight	44
8.6.4	Name	44
8.7	Hold Analog Outputs	45
9	System	46
9.1	Set Language	46
9.2	USB	46
9.3	Passwords	47
9.3.1	Changing Passwords	47
9.3.2	Configuring Menu Access for Operator	47
9.4	Set/Clear Lockout	48
9.5	Reset	48
9.5.1	Reset System	48
9.5.2	Reset Analog Calibration	48
10	Service	49
10.1	Diagnostics	49
10.1.1	Model/Software Revision	49
10.1.2	Digital Input	49
10.1.3	Display	50
10.1.4	Keypad	50
10.1.5	Memory	50
10.1.6	Set Relay	50
10.1.7	Read Relays	51
10.1.8	Set Analog Outputs	51
10.1.9	Read Analog Outputs	51
10.2	Calibrate	51
10.2.1	Calibrate Analog	52
10.2.2	Calibrate Unlock	52
10.3	Tech Service	52
11	Info	53
11.1	Messages	53
11.2	Calibration Data	53
11.3	Model/Software Revision	54
11.4	Sensor Info	54
12	Maintenance	55
12.1	Front Panel Cleaning	55
13	Troubleshooting	56
13.1	Cond (Resistivity) Error Messages / Warning- and Alarm List	57
13.2	Oxygen Error Messages / Warning- and Alarm List	57
13.3	pH Error Messages / Warning- and Alarm List	57
13.4	ORP Error Messages / Warning- and Alarm List	58

13.5	Warning- and Alarm Indication on the Display	58
13.5.1	Warning Indication	58
13.5.2	Alarm Indication	58
14	Accessories and Spare Parts	59
15	Specifications	60
15.1	General Specifications	60
15.2	Electrical Specifications	62
15.3	Mechanical Specifications	62
15.3.1	Mechanical Specifications for 1/2DIN Version	62
15.3.2	Mechanical Specifications for 1/4DIN Version	63
15.4	Environmental Specifications	63
16	Default Tables	64
16.1	M200 (1-channel Version)	64
16.2	M200 (2-channel Version)	65
16.3	Parameter Related Values	67
16.3.1	Conductivity	67
16.3.2	Oxygen	68
16.3.3	pH	69
16.3.4	ORP	70
16.3.5	Ozone	70
17	Warranty	71
18	Certificate	72
19	Buffer Tables	73
19.1	Mettler-9	73
19.2	Mettler-10	73
19.3	NIST Technical Buffers	74
19.4	NIST Standard Buffers (DIN 19266: 2000-01)	74
19.5	Hach Buffers	75
19.6	Ciba (94) Buffers	75
19.7	Merck Titrisole, Riedel-de-Haën Fixanale	76
19.8	WTW Buffers	76

1 Introduction

Statement of Intended Use – The M200 multi-parameter transmitter is a 1- or 2-channel online process instrument for measuring various properties of fluids. These include Conductivity/ Resistivity, Dissolved Oxygen, pH, ORP and Ozone. It will interface with a variety of different Mettler-Toledo sensors, which connect to the transmitter using cables of varied lengths.

A large four line backlit Liquid Crystal Display conveys measuring data and setup information. The menu structure allows the operator to modify all operational parameters by using keys on the front panel. A menu-lockout feature, with password protection, is available to prevent the unauthorized use of the meter. The M200 multi-parameter transmitter can be configured to use its 2 (4 on 2-channel version) analog and/or 2 relay outputs for process control.

The M200 multi-parameter transmitter is equipped with a USB communication interface. This interface provides real-time data output and complete instrument configuration capabilities for central monitoring via Personal Computer (PC).

This manual applies for all available M200 transmitters as follows:

- Multi-parameter 2-channel version
- Multi-parameter 1-channel version

The print screen images in this manual have a general explaining character and can differ from the real display in your transmitter.

2 Safety instructions

This manual includes safety information with the following designations and formats.

2.1 Definition of Equipment and Documentation Symbols and Designations



WARNING: POTENTIAL FOR PERSONAL INJURY.



CAUTION: possible instrument damage or malfunction.



NOTE: Important operating information.



On the transmitter or in this manual text indicates: Caution and/or other possible hazard including risk of electric shock (refer to accompanying documents).

The following is a list of general safety instructions and warnings. Failure to adhere to these instructions can result in damage to the equipment and/or personal injury to the operator.

- The M200 transmitter should be installed and operated only by personnel familiar with the transmitter and who are qualified for such work.
- The M200 transmitter must only be operated under the specified operating conditions (see section 15 “Specifications”).
- Repair of the M200 transmitter must be performed by authorized, trained personnel only.
- With the exception of routine maintenance, cleaning procedures or fuse replacement, as described in this manual, the M200 transmitter must not be tampered with or altered in any manner.
- Mettler-Toledo accepts no responsibility for damage caused by unauthorized modifications to the transmitter.
- Follow all warnings, cautions, and instructions indicated on and supplied with this product.
- Install equipment as specified in this instruction manual. Follow appropriate local and national codes.
- Protective covers must be in place at all times during normal operation.
- If this equipment is used in a manner not specified by the manufacturer, the protection provided by it against hazards may be impaired.

WARNINGS:

Installation of cable connections and servicing of this product require access to shock hazard voltage levels.

Main power and relay contacts wired to separate power source must be disconnected before servicing.

Switch or circuit breaker shall be in close proximity to the equipment and within easy reach of the OPERATOR; it shall be marked as the disconnecting device for the equipment.

Main power must employ a switch or circuit breaker as the disconnecting device for the equipment.

Electrical installation must be in accordance with the National Electrical Code and/or any other applicable national or local codes.



NOTE: RELAY CONTROL ACTION: the M200 transmitter relays will always de-energize on loss of power, equivalent to normal state, regardless of relay state setting for powered operation. Configure any control system using these relays with fail-safe logic accordingly.



NOTE: PROCESS UPSETS: Because process and safety conditions may depend on consistent operation of this transmitter, provide appropriate means to maintain operation during sensor cleaning, replacement or sensor or instrument calibration.

2.2 Correct Disposal of the Unit

When the transmitter is finally removed from service, observe all local environmental regulations for proper disposal.

3 Unit Overview

M200 models are available in both a 1/4DIN and 1/2DIN case size. The 1/4DIN is a panel-mount only design and the 1/2DIN models provide an integral IP65 housing for wall-, or pipe-mount.

3.1 Overview 1/4DIN

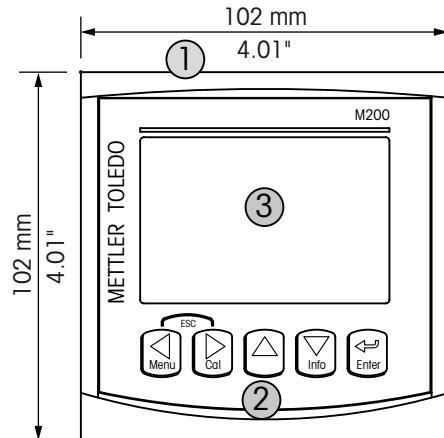

- 1 – Hard Polycarbonate case
- 2 – Five Tactile-Feedback Navigation Keys
- 3 – Four-line LC Display
- 4 – Power Supply Terminals

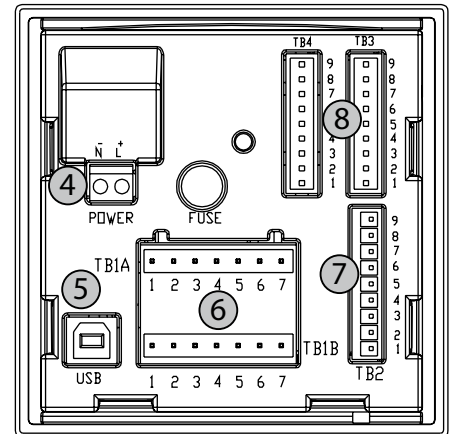

- 5 – USB Interface Port
- 6 – Relay Output Terminals
- 7 – Analog Output/Digital Input Terminals
- 8 – Sensor Input Terminals

3.2 Overview 1/2DIN

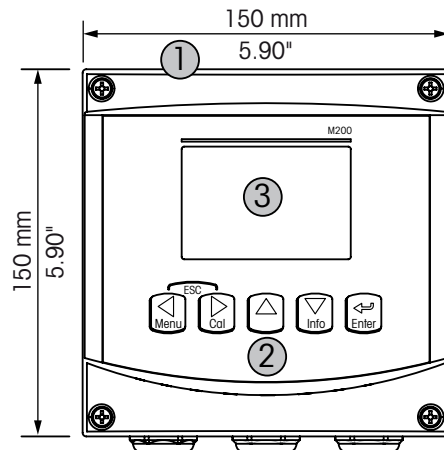

- 1 – Hard Polycarbonate case
- 2 – Five Tactile-Feedback Navigation Keys
- 3 – Four-line LC Display
- 4 – Power Supply Terminals

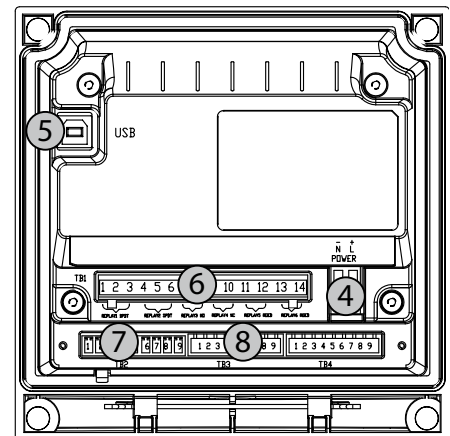

- 5 – USB Interface Port
- 6 – Relay Output Terminals
- 7 – Analog Output/Digital Input Terminals
- 8 – Sensor Input Terminals

3.3 Control/Navigation Keys

3.3.1 Menu Structure

Below is the structure of the M200 menu tree:

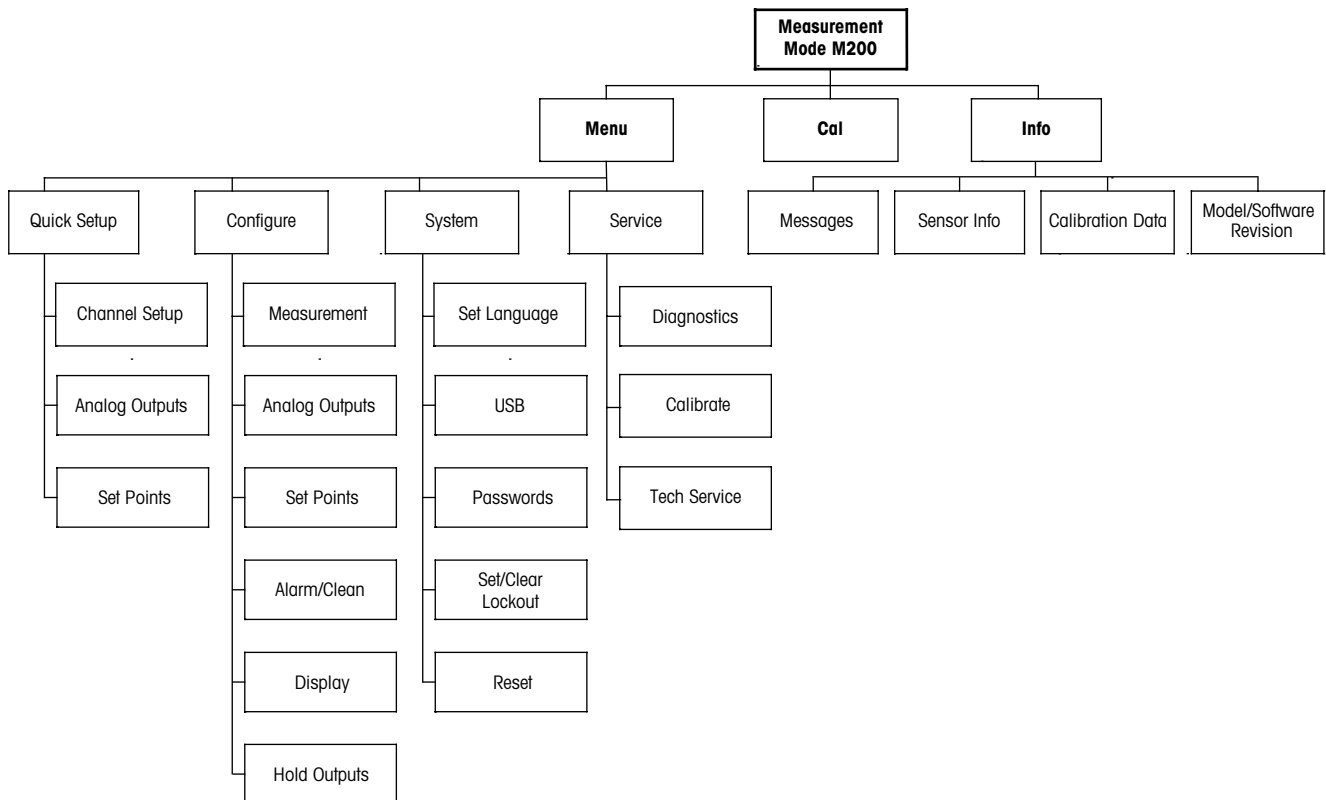

3.3.2 Navigation Keys

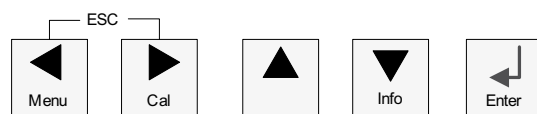

3.3.2.1 Navigating the Menu Tree

Enter the desired main Menu branch with the ◀▶ or ▼ keys. Use the ▲ and ▼ keys to navigate through the selected Menu branch.



NOTE: In order to back up one menu page, without escaping to the measurement mode, move the cursor under the UP Arrow character (⬆) at the bottom right of the display screen and press [Enter].

3.3.2.2 Escape

Press the ◀ and ▶ key simultaneously (escape) to return to the Measurement mode.

3.3.2.3 Enter

Use the ↵ key to confirm action or selections.

3.3.2.4 Menu

Press the ◀ key to access the main Menu.

3.3.2.5 Calibration Mode

Press the ▶ key to enter Calibration Mode.

3.3.2.6 Info Mode

Press the ▼ key to enter Info Mode

3.3.3 Navigation of Data Entry Fields

Use the ▶ key to navigate forward or the ◀ key to navigate backwards within the changeable data entry fields of the display.

3.3.4 Entry of Data Values, Selection of Data Entry Options

Use the ▲ key to increase or the ▼ key to decrease a digit. Use the same keys to navigate within a selection of values or options of a data entry field.

NOTE: Some screens require configuring multiple values via the same data field (ex: configuring multiple setpoints). Be sure to use the ▶ or ◀ key to return to the primary field and the ▲ or ▼ key to toggle between all configuration options before entering to the next display screen.



3.3.5 Navigation with ↑ in Display

If a ↑ is displayed on the bottom right hand corner of the display, you can use the ► or the ◀ key to navigate to it. If you click [ENTER] you will navigate backwards through the menu (go back one screen). This can be a very useful option to move back up the menu tree without having to exit into the measuring mode and re-enter the menu.

3.3.6 "Save changes" Dialog

Three options are possible for the "Save changes" dialog: Yes & Exit (Save changes and exit to measuring mode), "Yes & ↑" (Save changes and go back one screen) and "No & Exit" (Don't save changes and exit to measuring mode). The "Yes & ↑" option is very useful if you want to continue configuring without having to re-enter the menu.

3.3.7 Security Passwords

The M200 transmitter allows a security lock-out of various menus. If the security lock-out feature of the transmitter has been enabled, a security password must be entered to allow access to the menu. See section 9.3 "System / Passwords" for more information.

3.4 Display



NOTE: In the event of an alarm or other error condition the M200 transmitter will display a flashing ⚠ in the upper right corner of the display. This symbol will remain until the condition that caused it has been cleared.



NOTE: During calibrations, clean, Digital In with Analog Output/Relay/USB in Hold state, a flashing H will appear in the upper left corner of the display. This symbol will remain for 20 seconds until after the calibration or clean is completed. This symbol will also disappear when Digital In is deactivated.

4 Installation instruction

4.1 Unpacking and Inspection of Equipment

Inspect the shipping container. If it is damaged, contact the shipper immediately for instructions. Do not discard the box.

If there is no apparent damage, unpack the container. Be sure all items shown on the packing list are present.

If items are missing, notify your METTLER TOLEDO representative immediately.

4.2 Installation – 1/4DIN Models

4.2.1 1/4DIN Version – Dimension Drawings

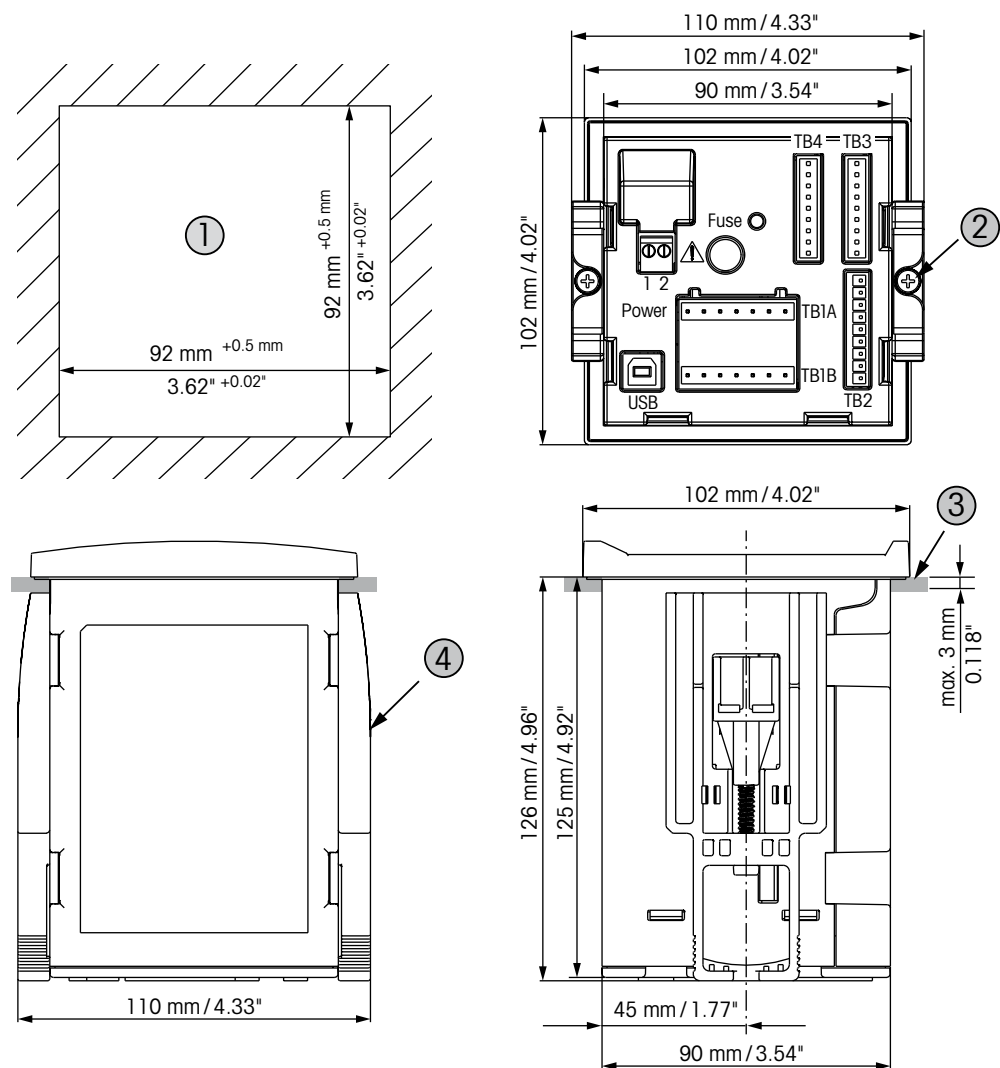

- 1 – Dimensions for panel cutout
- 2 – Mounting screws, 2 pieces
- 3 – Flat gasket, 1 piece
- 4 – Mounting bracket, 2 pieces

4.2.2 Installation Procedure – 1/4DIN Models

1/4DIN Model transmitters are designed for panel-mount installation only. Each transmitter is supplied with mounting hardware to provide fast and simple installation to a flat panel or flat enclosure door. To insure a good seal and maintain IP65 integrity of installation, the panel or door must be flat and have a smooth finish.

The supplied hardware consists of:

Two pieces snap-on mounting brackets

One piece mounting gasket seal

- Make cutout in panel. For dimensions refer to 4.2.1 “1/4DIN Version – Dimension Drawings”.
- Be sure surface surrounding cutout is clean, smooth and free of burrs.
- Slide face gasket around transmitter from the back of the unit.
- Place transmitter into cutout hole. Be sure there are no gaps between the transmitter and panel surface.
- Place the two mounting brackets on either side of the transmitter as shown.
- While holding transmitter firmly into the cutout hole, push the mounting brackets toward the backside of panel.
- Once secure, use a screwdriver to tighten the brackets against the panel. In order to provide IP65 environmental enclosure rating, the two clamps provided shall be securely tightened to create an adequate seal between the panel enclosure and M200 front face.
- Face gasket will compress between transmitter and panel.



CAUTION: Do not over tighten brackets.

4.3 Installation – 1/2DIN Models

4.3.1 1/2DIN Version – Dimension Drawings

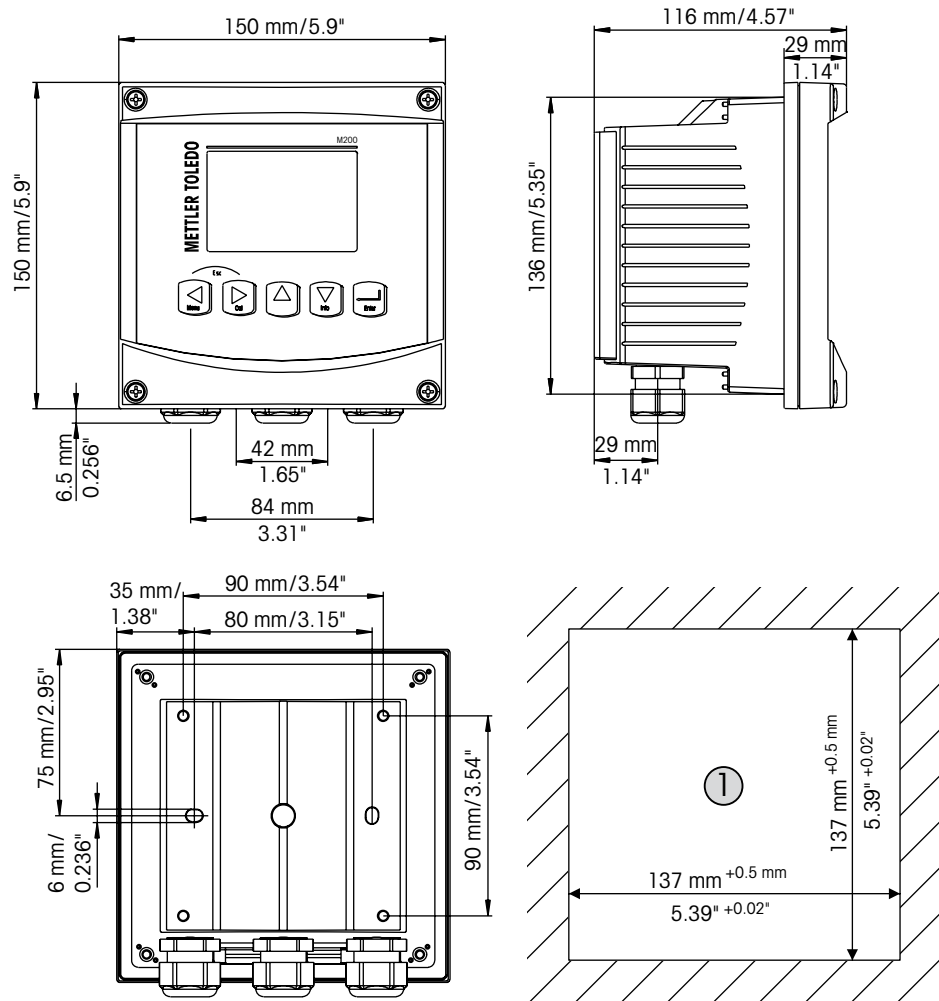

1 – Dimensions for panel cutout

4.3.2 1/2DIN Version – Pipe Mounting

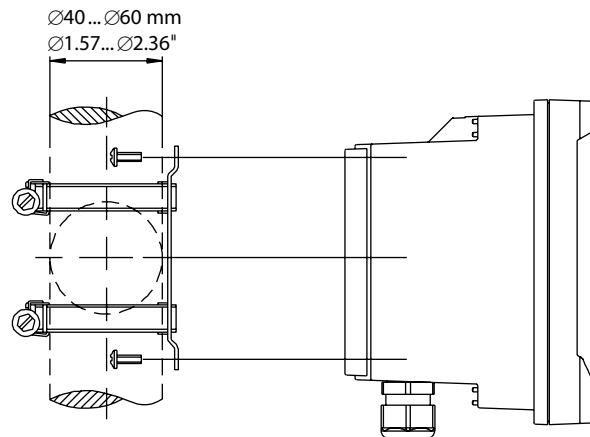

4.3.3 Installation Procedure – 1/2DIN Models

1/2DIN Model transmitters are designed for the following installation versions: panel mount, wall mount or pipe mount. For wall mount the integral rear cover is used. Optional hardware accessories are available that allow for panel- or pipe-mount. Refer to section 14 "Accessories and Spare Parts".

Assembly:

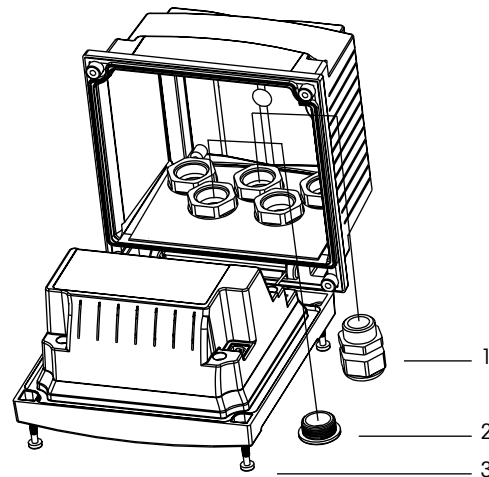

- 1 3 pieces M20 cable glands
- 2 2 pieces plastic plugs
- 3 4 pieces screws

General:

- Orient the transmitter so that the cable grips face downward.
- Wiring routed through the cable grips shall be suitable for use in wet locations.
- In order to provide IP65 enclosure ratings, all cable glands must be in place. Each cable gland must be filled using a cable, or suitable cable gland hole seal.

For Panel Mount:

To insure a good seal, the panel or door must be flat and have a smooth finish. Textured or rough surfaces are not recommended and may limit the effectiveness of the gasket seal provided.

- Make cutout in panel. For dimensions refer to 4.3.1 "1/2DIN Version – Dimension Drawings".
- Be sure surface surrounding cutout is clean, smooth and free of burrs.
- Slide face gasket around transmitter from the back of the unit.
- Place transmitter into cutout hole. Be sure there are no gaps between the transmitter and panel surface.
- Place the two mounting brackets on either side of the transmitter as shown.
- While holding transmitter firmly into the cutout hole, push the mounting brackets toward the backside of panel.
- Once secure, use a screwdriver to tighten the brackets against the panel. In order to provide IP65 environmental enclosure rating, the two clamps provided shall be securely tightened to create an adequate seal between the panel enclosure and M200 front face.
- Face gasket will compress between transmitter and panel.

For Wall Mount:

- Remove rear cover from front housing.
- Start by unscrewing the four screws located on the face of the transmitter, in each corner. This allows the front cover to swing away from the rear housing.
- Remove the hinge-pin by squeezing the pin from each end. This allows the front housing to be removed from the rear housing.
- Mount rear housing to wall using only manufacturer-supplied mounting kit. Secure mounting kit to the M200 according to the supplied instructions. Attach to wall using appropriate mounting hardware for wall surface. Be sure it is level and securely fastened and the installation adheres to any and all clearance dimensions required for transmitter service and maintenance. Orient the transmitter so that the cable grips are facing downward.
- Replace the front housing to the rear housing. Securely tighten the rear-cover screws to ensure that IP65 enclosure environmental rating is provided. The unit is ready to be wired.

For Pipe Mount:

- Use only manufacturer-supplied components for pipe-mounting the M200 transmitter and install per the supplied instructions. See section 14 "Accessories and Spare Parts" for ordering information.

4.4 Connection of Power Supply

All connections to the transmitter are made on the rear panel of all models.



Be sure power to all wires is turned off before proceeding with the installation. High voltage may be present on the input power wires and relay wires.

A two-terminal connector on the rear panel of all M200 models is provided for power connection. All M200 models are designed to operate from a 20–30 VDC or a 100 to 240 VAC power source. Refer to specifications for power requirements and ratings and size power wiring accordingly.

The terminal block for power connections is labeled “Power” on the rear panel of the transmitter. One terminal is labeled **-N** for the Neutral wire and the other **+L** for the Line (or Load) wire. There is no earth ground terminal on the transmitter. For this reason the internal power wiring within the transmitter is double insulated and the product label designates this using the  symbol.

4.4.1 1/4DIN Housing (Panel Mount)

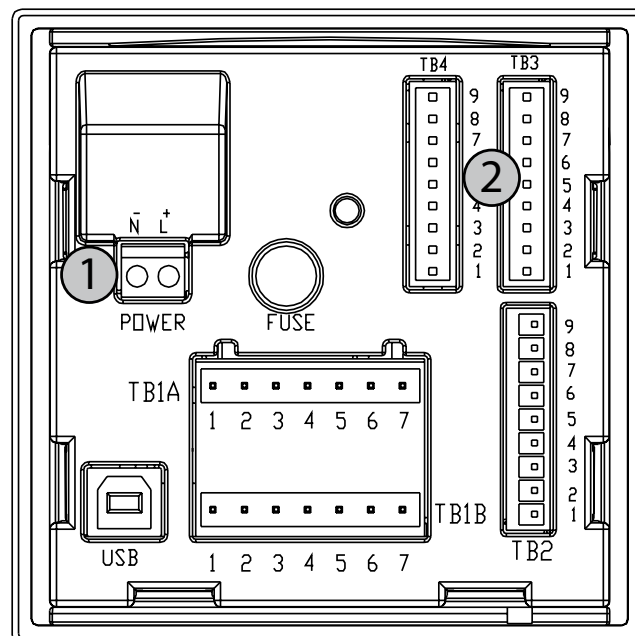

- 1: Connection of power supply
- 2: Terminal for sensors

4.4.2 1/2DIN Housing (Wall Mount)

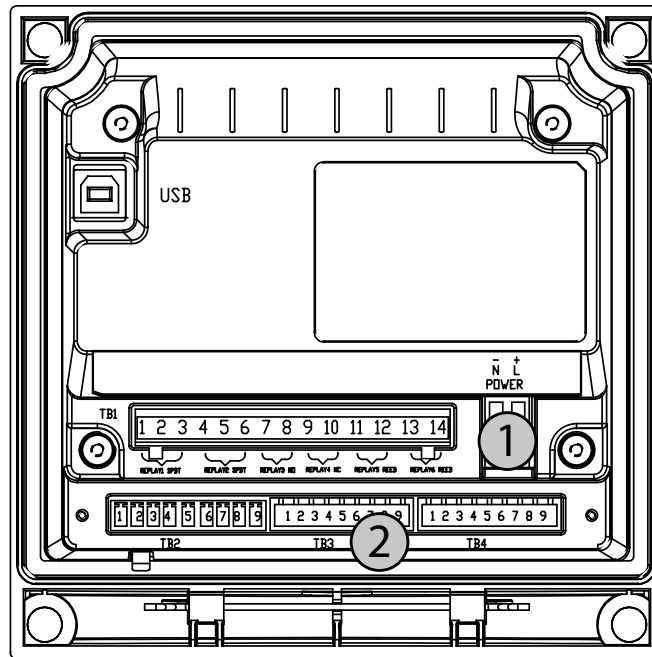

- 1: Connection of power supply
- 2: Terminal for sensors

4.5 Connector Terminal Definition

4.5.1 TB1 and TB2 for 1/2DIN and 1/4DIN Versions

Power connections are labeled **-N** for Neutral and **+L** for Line, for 100 to 240 VAC or 20–30 VDC.

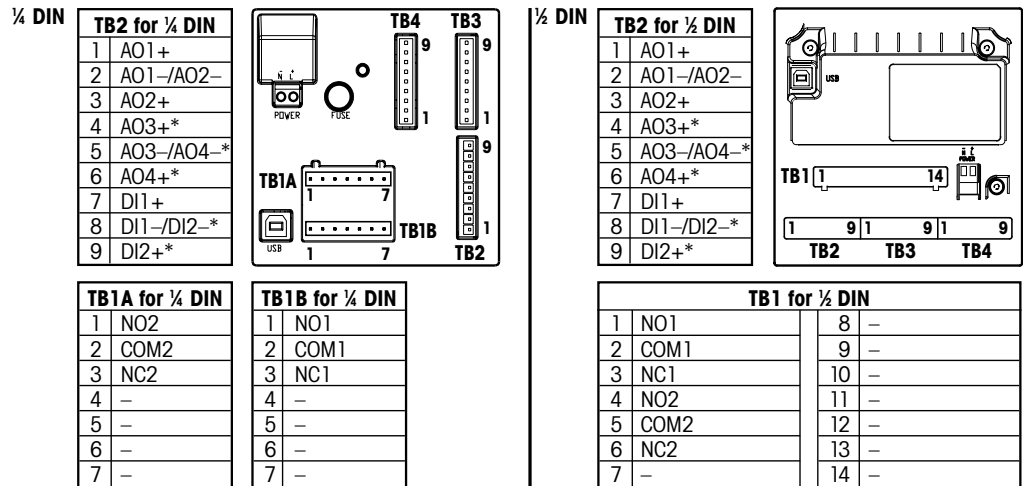

* Dual channel only

NO: normally open (contact open if un-actuated)
 NC: normally closed (contact closed if un-actuated)

AO: Analog Output
 DI: Digital Input

4.5.2 TB3/TB4* – pH, ORP, Dissolved Oxygen, Ozone and 4-Electrode Conductivity Sensor

The wiring of the sensors for pH, oxygen, ozone and 4-electrode conductivity to TB3 resp. TB4 is:

Terminal	Sensor wire color	Function
1	-	-
2	-	-
3	Cable core (transparent)	1-Wire
4	Shield (red)	GND (5 VDC)
5	-	-
6	-	GND (5 VDC)
7	-	RS485-B
8	-	RS485-A
9	-	5 VDC

* Only on 2-channel version.

4.5.3 TB3/TB4 – 2-electrode Conductivity Sensor

The wiring of the sensors for 2-electrode conductivity to TB3 resp. TB4 is:

Terminal	Sensor wire color*		Function
	easySense	UniCond	
1	–		–
2	–		–
3	–		1-Wire
4	–		GND (5 VDC)
5	–		–
6	Green	White	GND (5 VDC)
7	Orange	Black	RS485–B
8	White/Orange	Red	RS485–A
9	White/Green	Blue	5 VDC

* Bare wire not connected.

4.6 Assembling of Sensor and Cable

4.6.1 Connection of Sensors for pH, ORP, Dissolved Oxygen, Ozone and 4-electrode Conductivity

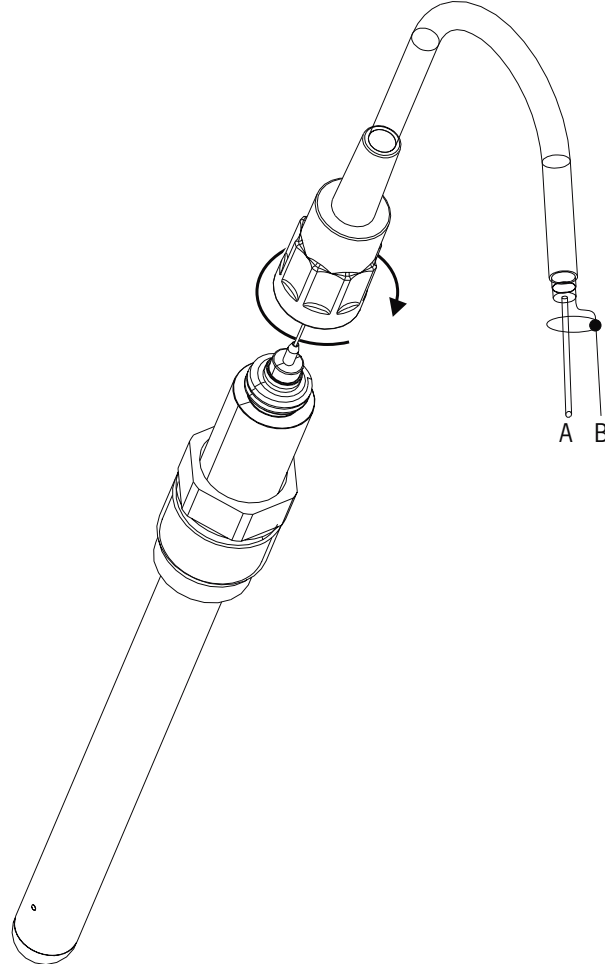

NOTE: Connect the sensor and screw the plug head clockwise (hand tight).

4.6.2 AK9 Cable Assignment

- A: 1-wire data (transparent)
- B: Ground/shield (red)

5 Placing transmitter in, or Out of Service

5.1 Placing Transmitter in Service



After connecting the transmitter to power supply circuit, it will be active as soon as the circuit is powered.

5.2 Placing Transmitter Out of Service

First disconnect the unit from the main power source, then disconnect all remaining electrical connections. Remove the unit from the wall/panel. Use the installation instruction in this manual as reference for dis-assembling mounting hardware.

6 Quick Setup

(PATH: Menu/Quick Setup)

Select Quick Setup and press the [ENTER] key. Enter the security code if necessary (see section 9.3 "Passwords").



Note: Please find the complete description of the Quick Setup routine described in the separate booklet "Quick Setup Guide for Transmitter M200" enclosed in the box.



Note: Refer to section 3.3 "Control/Navigation Keys" for information on menu navigation.

7 Sensor Calibration

(PATH: Cal)

The calibration key [CAL] allows the user one-touch access to Sensor calibration and verification features. The M200 also allows access to Analog Output calibration if the access has been previously unlocked (see section 10.2 "Calibrate").



NOTE: During Calibration, a flashing "H" in the upper left corner of the display indicates a calibration is in process with a Hold condition active. (The hold output function need to be activated.)

7.1 Enter Calibration Mode

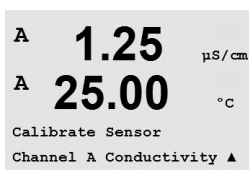

While in Measurement mode press the key [CAL]. If the display prompts you to enter the calibration security code, press the ▲ or ▼ key to set the calibration security code, then press the [ENTER] key to confirm the calibration security code.

For Multi-channel devices: Using the ▲ or ▼ key on the "Channel A" field lets the user change the channel to be calibrated. Then use the ► key to move to the calibration field.

Select the desired sensor calibration task. The choices for each sensor type are:

Conductivity = Conductivity, Resistivity, Verify
 Oxygen = Oxygen, Verify
 pH/ORP = pH, Verify
 ORP = ORP, Verify
 Ozone = Ozone, Verify

Press [ENTER].

7.2 Conductivity/Resistivity Calibration

This feature provides the ability to perform a one-point, two-point or process conductivity or Resistivity "Sensor" calibration. The procedure described below works for both types of calibrations. There is no reason to perform a two-point calibration on a two-electrode conductivity sensor. Four electrode sensors do require a two-point calibration. It is also not practical to calibrate resistivity sensors using (low conductivity) reference solutions. It is recommended that resistivity sensors be sent back to the factory for calibration. Consult factory for assistance.



NOTE: When performing calibration on a conductivity or resistivity sensor, results will vary depending on the methods, calibration apparatus and/or quality of reference standards used to perform the calibration.

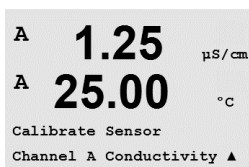

Enter conductivity sensor calibration mode as described in section 7.1 "Enter Calibration Mode".



After selecting the desired sensor calibration and pressing [ENTER], the next screen will ask to select the type of temperature compensation mode desired during the calibration process. The choices are "Standard", "Light 84", "Std 75 °C", "Lin 20 °C = 02.0%/°C" (user selectable value), "Lin 25 °C = 02.0%/°C" (user selectable value), "Glycol.5", "Glycol1", "Alcohol" and "Nat H₂O".

Press [ENTER].

7.2.1 One-point Sensor Calibration

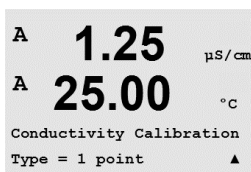

Enter conductivity sensor calibration mode as described in section 7.1 "Enter Calibration Mode" and choose one of the compensation modes (see section 7.2 "Conductivity/Resistivity Calibration").

(Display reflects typical conductivity sensor calibration)

Select 1 point Calibration and press [ENTER].



NOTE: Rinse sensors with a high-purity water solution before every calibration to prevent contamination of the reference solutions.

Place the sensor into the reference solution.

Enter the Value of calibration Point 1 and then press the [ENTER] key to start calibration. The value in the 2nd text line is the actual measured value from the sensor prior to calibration.

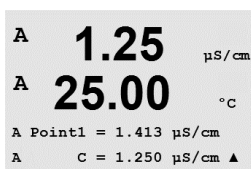

After the calibration the Multiplier or slope calibration factor "M" and the Adder or offset calibration factor "A" are displayed.

Select Yes to save the calibration values and the Successful Calibration is confirmed on the display.

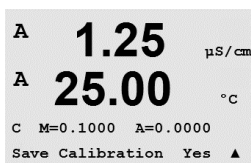

The user gets the message "Re-install sensor" and "Press Enter" on the display. After pressing [ENTER] the M200 returns to the measuring mode.

7.2.2 Two-point Sensor Calibration (4-electrode Sensors only)

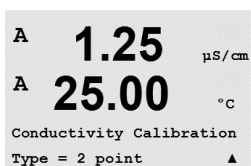

Enter conductivity sensor calibration mode as described in section 7.1 "Enter Calibration Mode" and choose one of the compensation modes (see section 7.2 "Conductivity/Resistivity Calibration").

Select 2 point Calibration and press [ENTER].



NOTE: Rinse sensors with a high-purity water solution between calibration points to prevent contamination of the reference solutions.

Place the sensor into the first reference solution.

```

A 1.25 μS/cm
A 25.00 °C
A Point2 = 0.055 μS/cm
A C = 0.057 μS/cm ▲

```

Enter the Value of Point 1 and press the [ENTER] key. Place the sensor into the second reference solution.

Enter the Value of Point 2 and press the [ENTER] key to start the calibration.

```

A 1.25 μS/cm
A 25.00 °C
C M=0.1000 A=0.0000
Save Calibration Yes ▲

```

After the calibration the Multiplier or slope calibration factor "M" and the Adder or offset calibration factor "A" are displayed.

Select Yes to save the calibration values and the Successful Calibration is confirmed on the display.

The user gets the message "Re-install sensor" and "Press Enter" on the display. After pressing [ENTER] the M200 returns to the measuring mode.

7.2.3 Process Calibration

Enter conductivity sensor calibration mode as described in section 7.1 "Enter Calibration Mode" and choose one of the compensation modes (see section 7.2 "Conductivity/Resistivity Calibration").

```

H 1.09 mS/cm
A 25.0 °C
Conductivity Calibration
Type = Process ↑

```

Select Process Calibration and press [ENTER].

```

A 1.09 mS/cm
A 25.0 °C
A Point1 = 00000 mS/cm
A C = 1.000 mS/cm ↑

```

Take a sample and press the [ENTER] key again to store the current measuring value.

During the ongoing calibration process, the letter of the channel, which is concerned by the calibration, "A" or "B" is blinking in the display.

After determining the conductivity value of the sample, press the [CAL] key again to proceed with the calibration.

```

1.09 mS/cm
25.0 °C
A Point1 = 1.000 mS/cm
A C = 1.000 mS/cm ↑

```

Enter the conductivity value of the sample then press the [ENTER] key to start the calculation of calibration results.

```

A 1.09 mS/cm
A 25.0 °C
C M=0.00109 A=0.00000
Save Calibration Yes ↑

```

After the calibration the Multiplier or slope calibration factor "M" and the Adder or offset calibration factor "A" are displayed.

Select Yes to save the calibration values and the Successful Calibration is confirmed on the display.

7.3 Oxygen Calibration

Dissolved Oxygen calibration is performed as either a one-point or process calibration.

7.3.1 One-Point Sensor Calibration

Before air calibration, for highest accuracy, enter the barometric pressure and relative humidity as in section 8.2.3.3 "Configuration/Measurement/Parameter Related Settings/Dissolved Oxygen Parameters" described.

Enter Oxygen Calibration mode as described in section 7.1 "Enter Calibration Mode".

A DO sensor calibration is always either a one-point Air (Slope) or a Zero (Offset) calibration. A one-point slope calibration is done in air and a one-point offset calibration is done at 0 ppb DO. A one-point zero dissolved oxygen calibration is available but not normally recommended since zero DO is very hard to achieve.

Select 1 point followed by either Slope or ZeroPt as the calibration type. Press [ENTER].

```
A 1.25  μS/cm
A 25.00 °C
Calibrate Sensor
Channel B Oxygen ▲
```

```
A 1.25  μS/cm
A 25.00 °C
O2 Calibration
Type = 1 point Slope ▲
```

```
A 1.25  μS/cm
A 25.00 °C
B Point1 = 100.0 ppb
B O2 = 101.3 ppb ▲
```

```
A 1.25  μS/cm
A 25.00 °C
O2 S=0.1000 Z=0.0000
Save Calibration Yes ▲
```

Enter the value for Point 1 including a decimal point and units. The value in the second text line is the value being measured by the transmitter and sensor in the units selected by the user. Press [ENTER] when this value is stable to perform the calibration.

After the calibration the slope calibration factor S and the offset calibration factor Z are displayed.

Select Yes to save the calibration values and the successful Calibration is confirmed on the display.

The user gets the message "Re-install sensor" and "Press ENTER" on the display. After pressing [ENTER] the M200 returns to the measuring mode.

7.3.2 Process Calibration

Enter Oxygen Calibration mode as described in section 7.1 "Enter Calibration Mode".

Select Process followed by either Slope or ZeroPt as the calibration type. Press [ENTER]

Take a sample and press the [ENTER] key again to store the current measuring Value. To show the ongoing calibration process, A or B (depending on the channel) is blinking in the display.

```
A 1.25  μS/cm
A 25.00 °C
O2 Calibration
Type = Process Slope ▲
```

```
A 1.25  μS/cm
A 25.00 °C
B Point1 = 100.0 ppb
B O2 = 101.3 ppb ▲
```

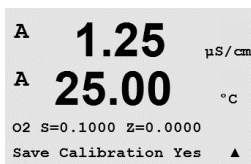

After determining the O₂ Value of the sample press the [CAL] key again to proceed with the calibration. Enter the O₂ value of the sample then press the [ENTER] key to start calibration.

After the calibration the slope calibration factor S and the offset calibration factor Z are displayed. Select Yes to save the new calibration values and the successful Calibration is confirmed on the display.

7.4 pH Calibration

For pH sensors, the M200 transmitter features one-point, two-point (Auto or Manual mode) or process calibration with 8 preset buffer sets or manual buffer entry. Buffer values refer to 25 °C. To calibrate the instrument with automatic buffer recognition, you need a standard pH buffer solution that matches one of these values. (See section 8.2.3.2 "pH Parameters" for configuring modes). Please select the correct buffer table before using automatic calibration (see chapter 19 "Buffer Tables").

Enter pH Calibration mode as described in section 7.1 "Enter Calibration Mode".

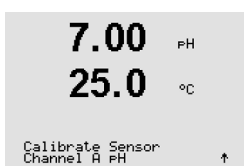

7.4.1 One-Point Calibration

Select 1 point Calibration.

Depending on the parameterized Drift control (see section 8.2.3.2 "pH Parameters") one of the two following modes is active.

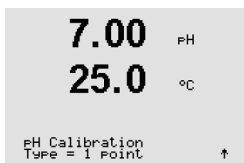

7.4.1.1 Auto Mode

Place the electrode in the buffer solution and press the [ENTER] key to start the calibration.

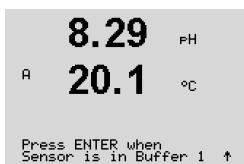

The display shows the buffer the transmitter has recognized (Point 1) and the measured value.

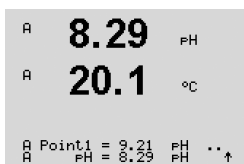

As soon as the drift conditions have stabilized the display changes to show the slope calibration factor S and the offset calibration factor Z.

Select Yes to save the calibration values and the successful Calibration is confirmed on the display.

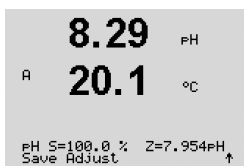

The user gets the message "Re-install sensor" and "Press Enter" on the display. After pressing [ENTER] the M200 returns to the measuring mode.

7.4.1.2 Manual mode

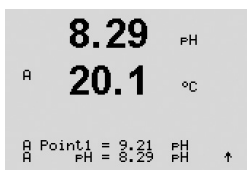

Place the electrode in the buffer solution. The display shows the buffer the transmitter has recognized (Point 1) and the measured value. Press [ENTER] to proceed.

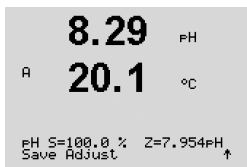

The display shows now the slope calibration factor S and the offset calibration factor Z.

Select Yes to save the calibration values and the successful Calibration is confirmed on the display.

The user gets the message "Re-install sensor" and "Press Enter" on the display. After pressing [ENTER] the M200 returns to the measuring mode.

7.4.2 Two-Point Calibration

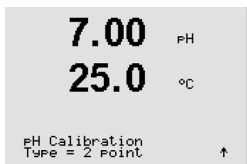

Select 2 point Calibration.

Depending on the parameterized Drift control (see section 8.2.3.2 "pH Parameters") one of the two following modes is active.

7.4.2.1 Auto Mode

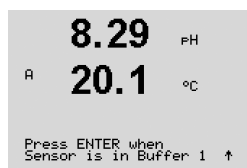

Place the electrode in the first buffer solution and then press the [ENTER] key.

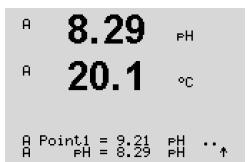

The display shows the buffer the transmitter has recognized (Point 1) and the measured value.

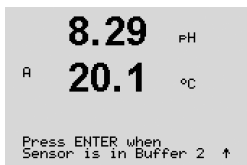

As soon as the drift conditions have stabilized, the display changes and prompts you to place the electrode in the second buffer.

Place the electrode in the second buffer solution and press the [ENTER] key to go on with the calibration.

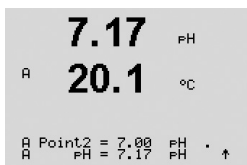

The display shows the second buffer the transmitter has recognized (Point 2) and the measured value.

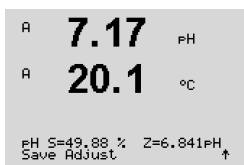

As soon as the drift conditions have stabilized the display changes to show the slope calibration factor S and the offset calibration factor Z.

Select Yes to save the calibration values and the successful Calibration is confirmed on the display.

The user gets the message "Re-install sensor" and "Press Enter" on the display. After pressing [ENTER] the M200 returns to the measuring mode.

7.4.2.2 Manual Mode

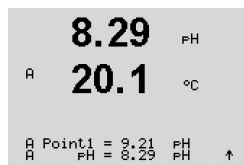

Place the electrode in the first buffer solution. The display shows the buffer the transmitter has recognized (Point 1) and the measured value. Press [ENTER] to proceed.

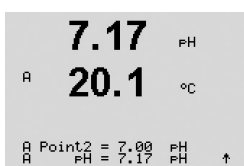

Place the transmitter in the second buffer solution. The display shows the buffer the transmitter has recognized (Point 2) and the measured value. Press [ENTER] to proceed.

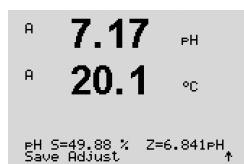

The display shows the slope calibration factor S and the offset calibration factor Z.

Select Yes to save the calibration values and the successful Calibration is confirmed on the display.

The user gets the message "Re-install sensor" and "Press Enter" on the display. After pressing [ENTER] the M200 returns to the measuring mode.

7.4.3 Process Calibration

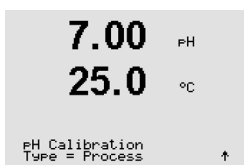

Select Process Calibration.

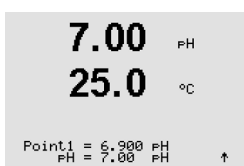

Take a sample and press the [ENTER] key again to store the current measuring Value. To show the ongoing calibration process, A or B (depending on the channel) is blinking in the display.

After determining the pH Value of the sample, press the [CAL] key again to proceed with the calibration.

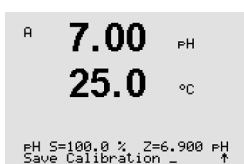

Enter the pH value of the sample then press the [ENTER] key to start calibration.

After the calibration the slope calibration factor S and the offset calibration factor Z are displayed. Select Yes to save the new calibration values and the successful Calibration is confirmed on the display.

7.5 ORP Calibration

For ORP sensors, the M200 features one-point calibration.
Enter ORP Calibration mode as described in section 7.1 "Enter Calibration Mode".

7.5.1 One-Point Calibration

The M200 automatically performs 1-point calibration for the parameter ORP.

Enter the value of calibration Point 1 and then press the [ENTER] key to start calibration.

The value in the 2nd text line is the actual measured value from the sensor prior to calibration.

The display shows the slope calibration factor S, which is always 1.00000 and the offset calibration factor Z.

Select Yes to save the calibration values and the successful Calibration is confirmed on the display.

The user gets the message "Re-install sensor" and "Press Enter" on the display. After pressing [ENTER] the M200 returns to the measuring mode.

```

100.0 mU ORP
Point1 = 97.00 mU
ORP = 100.0 mU ↑

```

```

A 100.0 mU ORP
mU S=1.00000 Z=-3.0000
Save Calibration Yes ↑

```

7.6 Ozone Calibration

Ozone calibration is performed as either a one-point or process calibration.

7.6.1 One-Point ZeroPt Calibration

Enter Ozone calibration mode as described in section 7.1 "Enter Calibration Mode".

Select 1 point ZeroPt as the calibration type.
Press [ENTER].

Enter the value for Point 1 including a decimal point. Ozone is the value being measured by the transmitter and sensor in the units set by the user. Press [ENTER] when this value is stable to perform the calibration.

As soon as the stabilization criteria have been fulfilled the display changes. The display shows the calibration result for slope "S" and offset value "Z".

The user gets the message "Re-install sensor" and "Press ENTER" on the display. After pressing [ENTER] the M200 returns to the measuring mode.

```

B 15.0 PPb03
B 25.0 °C
Calibrate Sensor
Channel B 03 ↑

```

```

B 15.0 PPb03
B 25.0 °C
O3 Calibration
Type = 1 Point ZeroPt ↑

```

```

B 15.0 PPb03
B 25.0 °C
Point1 = 0.000 PPb 03
O3 = 15.0 PPb ↑

```

```

B 15.0 PPb03
B 25.0 °C
O3 S=-0.110nA Z=-1.650nA
Save Adjust ↑

```

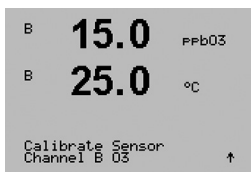

7.6.2 Process Calibration

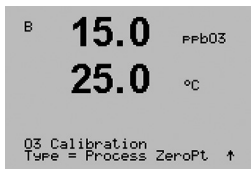

Enter Ozone calibration mode as described in section 7.1 "Enter Calibration Mode". An ozone sensor Process calibration is either a Slope or Zero Pt calibration. The Slope calibration is always obtained from a comparison instrument or colorimetric test kit. The Zero Pt calibration is done in air or in ozone-free water.

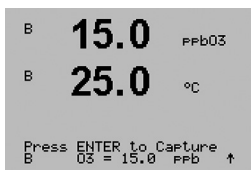

Select Process followed by either Slope or ZeroPt as the calibration type. Press [ENTER].



Take a sample and press the [ENTER] key again to store the current measuring value.

After determining the O₃ value of the sample press the ► key again to proceed with the calibration.

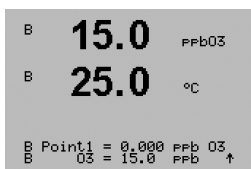

Enter the O₃ value of the sample. Press the [ENTER] key to start the calculation of the calibration results.

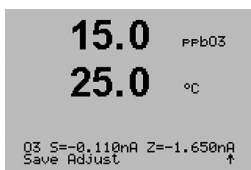

After the calibration the slope "S" and the offset value "Z" are displayed.

Select Yes to save the calibration values and the successful Calibration is confirmed on the display.

The user gets the message "Re-install sensor" and "Press ENTER" on the display. After pressing [ENTER] the M200 returns to the measuring mode.

7.7 Sensor Verification

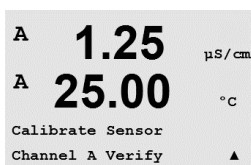

Enter Calibration mode as described in section 7.1 "Enter Calibration Mode" and select Verify.



The measured signal of the primary and the secondary measurement in electrical units are shown.

Use the ▲ or ▼ key to toggle between Channel A and B*.

* Only on 2-channel version.

8 Configuration

(PATH: Menu/Configure)

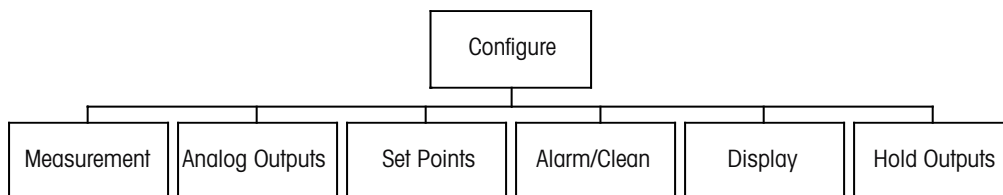

8.1 Enter Configuration Mode



While in Measurement mode, press the [MENU] key. Press the ▲ or ▼ key to navigate to the Configure – Menu and press [ENTER].

8.2 Measurement

(PATH: Menu/Configure/Measurement)

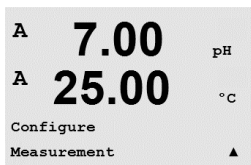

Enter configuration mode as described in section 8.1 “Enter Configuration Mode”.

Press the [ENTER] key to select this Menu. The following sub menus can now be selected: Channel Setup, Comp/pH/O₂ and Set Averaging.

8.2.1 Channel Setup

Press the [ENTER] key to select the “Channel Setup” Menu.

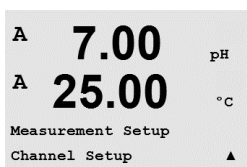

Select Sensor Type and press [ENTER].

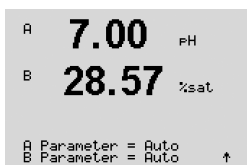

- pH/ORP = pH/ORP measurement
- O₂ hi = Dissolved oxygen (ppm)
- Cond (2) = 2 electrode conductivity
- Cond (4) = 4 electrode conductivity
- ORP = ORP measurement
- Ozone = Ozone measurement
- Auto: = The transmitter automatically recognizes the connected sensor

If you select a specific parameter instead of auto, the transmitter only accepts the selected parameter type.



The 4 lines of the display can now be configured with sensor channel "A" or "B" for each line of the display as well as measurements and unit multipliers. Pressing the [ENTER] key will display the selection for lines c and d.

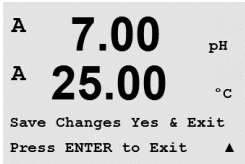

Pressing the [ENTER] key again will bring up the Save Changes dialog. Selecting No will discard the entered values and return to the measurement display screen, selecting Yes will save changes made.

8.2.2 Derived Measurements

There are three derived measurements available for configuration with two conductivity sensors: %Rej (% Rejection), pH Cal (Calculated pH) and CO₂ Cal (Calculated CO₂). To set up any of the derived measurements, first set up the two primary conductivity measurements, which will be used to calculate the derived measurement. Define the primary measurements as if they were stand-alone readings. Then the derived measurement can be defined.

NOTE: It is important to use the same units for both measurements.

8.2.2.1 % Rejection measurement

For reverse osmosis (RO) applications, percent rejection is measured with conductivity to determine the ratio of impurities removed from product or permeate water to the total impurities in the incoming feed water. The formula for obtaining Percent Rejection is:

$$[1 - (\text{Product/Feed})] \times 100 = \% \text{ Rejection}$$

Where Product and Feed are the conductivity values measured by the respective sensors.

Figure 4.1 shows a diagram of an RO installation with sensors installed for Percent Rejection.

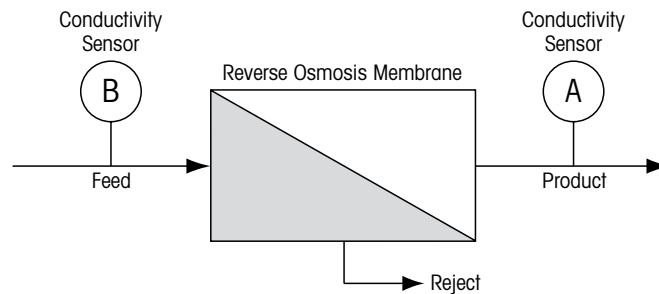

Figure 4.1: % Rejection

NOTE: The product monitoring sensor must be on the channel that will measure percent rejection. If the product conductivity sensor is installed in channel A, then percent rejection must be measured in channel A.

8.2.2.2 Calculated pH (Power Plant Applications only)

Calculated pH may be obtained very accurately from specific and cation conductivity values on power plant samples when the pH is between 7.5 and 10.5 due to ammonia or amines and when the specific conductivity is significantly greater than the cation conductivity. This calculation is not suitable where significant levels of phosphates are present. The M200 uses this algorithm when pH CAL is selected as a measurement.

The calculated pH must be configured on the same channel as specific conductivity. For example, set up measurement "a" on channel A to be specific conductivity, measurement "b" on Channel B to be cation conductivity, measurement "c" on channel A to be calculated pH and measurement "d" on channel A to be temperature. Set the temperature compensation mode to "Ammonia" for measurement "a" and to "Cation" for measurement "b".



NOTE: If operation goes outside the recommended conditions, a glass electrode pH measurement is needed to obtain an accurate value. On the other hand, when sample conditions are within the ranges noted above, the calculated pH provides an accurate standard for one-point trim calibration of the electrode pH measurement.

8.2.2.3 Calculated CO₂ (Power Plant Applications only)

Carbon dioxide may be calculated from cation conductivity and degassed cation conductivity measurements on power plant samples using tables from ASTM Standard D4519. The M200 has these tables stored in memory, which it uses when units of CO₂ CAL are selected.

The calculated CO₂ measurement must be configured to the same channel as cation conductivity. For example, set up measurement "a" on channel A to be cation conductivity, measurement "b" on channel B to be degassed cation conductivity, measurement "c" on channel A to be calculated CO₂ and measurement "d" on channel B to be temperature. Set the temperature compensation mode to "Cation" for both conductivity measurements.

8.2.3 Parameter Related Settings

Additional measurement and calibration parameters can be set for each parameter; conductivity, pH and O₂.

Enter Configuration Mode as described in section 8.1 "Enter Configuration mode" and select the menu Measurement (see section 8.2 "Configuration/Measurement").

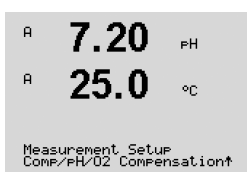

For 2-channel devices: The menu Comp/pH/O₂ can be selected by using the ▲ or ▼ key. Then use the ► key to move to the next line and select the parameter. The choices are Resistivity (for conductivity measurement), pH and O₂. Press [ENTER]

For 1-channel devices: Depending on the connected sensor the following parameter is shown in the display: Resistivity (for conductivity measurement), pH or O₂. Press [ENTER]

For more details, please see the following explanations depending on the selected parameter.

8.2.3.1 Conductivity/Temperature Compensation

Select Resistivity and press [ENTER].

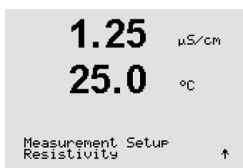

The temperature compensation mode for any of the four measurement lines can be selected. Temperature compensation should be matched to the characteristics of the application. Choices are "Standard", "Light 84", "Std 75 °C", "Lin 20 °C", "Lin 25 °C", "Nat H2O", "Glycol.5", "Glycol1", "Cation", "Alcohol" and "Ammonia".

If compensation mode "Lin 25 °C" or "Lin 20 °C" has been chosen, the factor for the adjustment of the reading can be modified after pressing [ENTER] (If working at measurement line 1 or 2 press [ENTER] twice).

Pressing [ENTER] will bring up the Save Changes dialog. Selecting No will discard the entered values and return to the measurement display screen, selecting Yes will save changes made.

Standard compensation includes compensation for non-linear high purity effects as well as conventional neutral salt impurities and conforms to ASTM standards D1125 and D5391.

Std 75 °C compensation is the Standard compensation algorithm referenced to 75 °C. This compensation may be preferred when measuring Ultrapure Water at an elevated temperature. (Resistivity of ultrapure water compensated to 75 °C is 2.4818 Mohm-cm.)

Lin 20 °C compensation adjusts the reading by a factor expressed as a "% per °C" (deviation from 20 °C). Use only if the solution has a well-characterized linear temperature coefficient. The factory default setting is 2.0%/°C.

Nat H₂O compensation includes the compensation to 25 °C according to EN27888 for natural water.

Lin 25 °C compensation adjusts the reading by a factor expressed as a "% per °C" (deviation from 25 °C). Use only if the sample has a well-characterized linear temperature coefficient. The factory default setting is 2.0%/°C.

Glycol.5 compensation matches the temperature characteristics of 50% ethylene glycol in water. Compensated measurements using this solution may go above 18 Mohm-cm.

Glycol1 compensation matches the temperature characteristics of 100% ethylene glycol. Compensated measurements may go well above 18 Mohm-cm.

Cation compensation is used in power industry applications measuring the sample after a cation exchanger. It takes into account the effects of temperature on the dissociation of pure water in the presence of acids.

Alcohol compensation provides for the temperature characteristics of a 75% solution of isopropyl alcohol in pure water. Compensated measurements using this solution may go above 18 Mohm-cm.

Light 84 compensation matches the high purity water research results of Dr. T.S. Light published in 1984. Use only if your institution has standardized on that work.

Ammonia compensation is used in power industry applications for specific conductivity measured on samples using ammonia and/or ETA (ethanolamine) water treatment. It takes into account the effects of temperature on the dissociation of pure water in the presence of these bases.

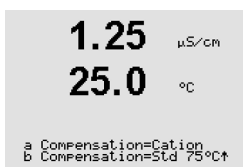

8.2.3.2 pH Parameters

Select pH and press [ENTER].

```
A 7.00 pH
A 25.00 °C
Measurement Setup
Comp/pH/O2 pH ▲
```

```
A 7.00 pH
A 25.00 °C
A:Drift Control = Auto
B:Drift Control =Manual▲
```

Select the Drift control for calibration as Auto (drift and time criteria have to be fulfilled) or Manual (The user can decide when a signal is stable enough to complete calibration) followed by the relevant buffer table for the automatic buffer recognition. If the drift rate is less than 0.8 mV over a 20 second interval then the reading is stable and the calibration is done using the last reading. If the drift criteria is not met within 300 seconds then the calibration times out and the message "Calibration not done" is displayed.

```
A 7.00 pH
A 25.00 °C
A:pH Buffer= Mettler-9
B:pH Buffer= Mettler-10▲
```

For automatic buffer recognition during calibration, select the buffer solution set that will be used: Mettler-9, Mettler-10, NIST Tech, NIST Std, HACH, CIBA, MERCK, WTW or None. See section 19 "Buffer tables" for buffer values. If the auto buffer feature will not be used or if the available buffers are different from those above, select None.

```
A 7.00 pH
A 25.00 °C
A:STC = 0.000 pH/°C
B:STC = 0.000 pH/°C ▲
```

STC is the solution temperature coefficient in units of pH/°C referenced to 25 °C (Default = 0.000 for most applications). For pure waters, a setting of 0.016 pH/°C should be used. For low conductivity power plant samples near 9 pH, a setting of 0.033 pH/°C should be used. These positive coefficients compensate for the negative temperature influence on the pH of these samples.

```
A 7.00 pH
A 25.00 °C
A:IP = 7.000 pH
B:IP = 7.000 pH ▲
```

IP is the isothermal point value (Default = 7.000 for most applications). For specific compensation requirements or non standard inner buffer value, this value can be changed.

```
A 7.00 pH
A 25.00 °C
A:Fix CalTemp No
B:Fix CalTemp Yes 25.00▲
```

"Fixed" allows a specific temperature value to be entered. Selecting "No" means the temperature given by the digital sensor connected to the channel will be used for the Calibration.

Pressing [ENTER] again will bring up the Save Changes dialog. Selecting No will discard the entered values and return to the measurement display screen, selecting Yes will save changes made.

8.2.3.3 Dissolved Oxygen Parameters

Select O₂ and press [ENTER]

```
A 21.7 %sat
A 25.00 °C
Measurement Setup
Comp/pH/O2 O2 ▲
```

```
A 21.7 %sat
H 25.0 °C
A:CalPres = 759.8 mmHg
B:CalPres = 759.8 mmHg ↑
```

Enter the Calibration pressure. The default value for CalPres is 759.8 and the default unit is mmHg.



Enter the Process Pressure. The units for ProcPres and CalPres do not have to be the same.

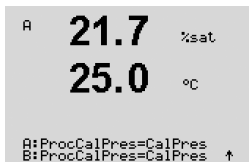

For the algorithm of the process calibration the applied pressure (ProcCalPres) has to be defined. The value of the process pressure (ProcPres) or the calibration pressure (CalPres) can be used. Chose the pressure, that applies during the process calibration, resp. should be used for the algorithm and press [ENTER].

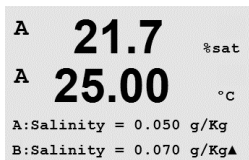

The salinity of the measured solution and the relative humidity of the calibration gas can also be entered. The allowed values for Relative Humidity are in the range 0% to 100%.

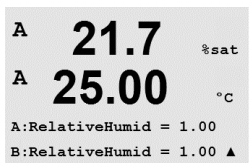

Pressing the [ENTER] key again will bring up the Save Changes dialog. Selecting No will discard the entered values and return to the measurement display screen, selecting Yes will save changes made.

8.2.4 Set Averaging

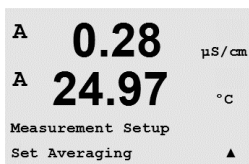

Press the [ENTER] key to select this Menu. The averaging method (noise filter) for each measurement line can now be selected. The options are Special (Default), None, Low, Medium and High:

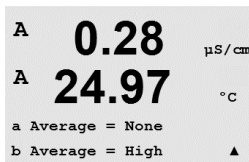

- None = no averaging or filtering
- Low = equivalent to a 3 point moving average
- Medium = equivalent to a 6 point moving average
- High = equivalent to a 10 point moving average
- Special = averaging depending on signal change (normally High averaging but Low averaging for large changes in input signal)

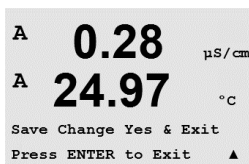

Pressing the [ENTER] key again will bring up the Save Changes dialog. Selecting No will discard the entered values and return to the measurement display screen, selecting Yes will save changes made.

8.3 Analog Outputs

(PATH: Menu/Configure/Analog Outputs)

Enter configuration mode as described in section 8.1 "Enter Configuration Mode".

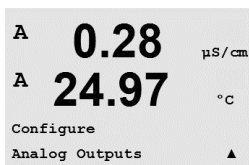

Go to the menu Analog Output by using the ▲ or ▼ key. Press the [ENTER] key to select this Menu, which lets you configure the 2 (4 for 2-channel version) Analog Outputs. Once analog outputs have been selected, use the ◀ and ▶ keys to navigate between configurable parameters. Once a parameter is selected, its setting can be selected per the following table:

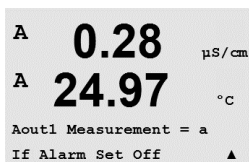

When an Alarm Value is selected, the analog output will go to this value if any alarm condition occurs.

Parameter	Selectable Values
Aout:	1, 2, 3* or 4* (default is 1)
Measurement:	a, b, c, d or blank (none) (default is blank)
Alarm Value:	3.6 mA, 22.0 mA or Off (default is off)

* Only on 2-channel version.

The range can be 4–20 mA or 0–20 mA.

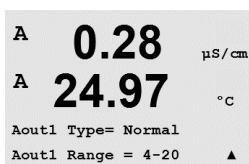

Enter the minimum and maximum Value of Aout.

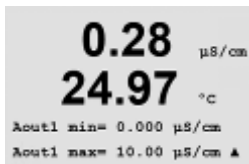

If Auto-range was selected then Aout max1 can be configured. Aout max1 is the maximum value for the first range on Auto-Range. The maximum value for the second range on Auto-Range was set in the previous menu. If Logarithmic Range was selected, it will also prompt for the number of decades as "Aout1 # of Decades =2".

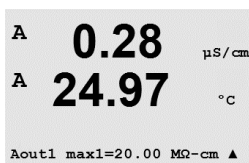

The value for the Hold mode can be configured to hold the Last value or can be set to a Fixed value.



Pressing the [ENTER] key again will bring up the Save Changes dialog. Selecting No will discard the entered values and return to the measurement display screen, selecting Yes will save changes made.

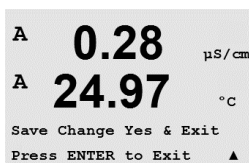

8.4 Setpoints

(PATH: Menu/Configure/Setpoints)

Enter configuration mode as described in section 8.1 "Enter Configuration Mode".

Go to the menu Set Points by using the ▲ or ▼ key.

Press the [ENTER] key to select this Menu.

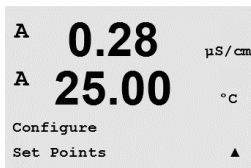

4 (6 for 2-channel version) Setpoints can be configured on any of the measurements (a thru d). The possible Setpoint types are Off, High, Low, Outside, Between, USP (% safety margin below U.S. Pharmacopoeia limits), EP PW (% safety margin below European Pharmacopoeia limits for Purified Water) and EPWFI (% safety margin below European Pharmacopoeia limits for Water for Injection).

An "Outside" Setpoint will cause an alarm condition whenever the measurement goes above its high limit or below its low limit. A "Between" Setpoint will cause an alarm condition to occur whenever the measurement is between its high and low limits.

Enter the desired value(s) for the Setpoint and press [ENTER]

This screen provides the option to configure a setpoint to be active on an over range condition. Select the setpoint and "Yes" or "No". Select the desired relay that will activate when the setpoint alarm condition is reached.



Over Range

Once configured, the selected relay will be activated if a sensor over-range condition is detected on the assigned input channel.

Delay

Enter the delay time in seconds. A time delay requires the setpoint to be exceeded continuously for the specified length of time before activating the relay. If the condition disappears before the delay period is over, the relay will not be activated.



Hysteresis

Enter the hysteresis as a percentage-value. A hysteresis value requires the measurement to return within the setpoint value by a specified percentage before the relay is deactivated.

For a high setpoint, the measurement must decrease more than the indicated percentage below the setpoint value before the relay is deactivated. With a low setpoint, the measurement must rise at least this percentage above the setpoint value before the relay is deactivated. For example, with a high setpoint of 100, when this value is exceeded, the measurement must fall below 90 before the relay is deactivated.

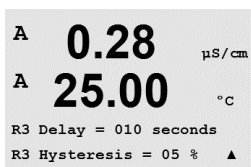

Hold

Enter the Relay Hold Status of "Last", "On" or "Off". This is the state the Relay will go to during a Hold status.

State

Relay contacts are in normal state until the associated setpoint is exceeded, then the relay is activated and the contact states change.



Select "Inverted" to reverse the normal operating state of the relay (i.e. Normally open contacts are in a closed state, and normally closed contacts are in an open state, until the setpoint is exceeded). "Inverted" relay operation is functional when power is applied to the M200 transmitter.

Pressing the [ENTER] key again will bring up the Save Changes dialog. Selecting No will discard the entered values and return to the measurement display screen, selecting Yes will save changes made.

8.5 Alarm/Clean

(PATH: Menu/Configure/Alarm/Clean)



Enter configuration mode as described in section 8.1 "Enter Configuration Mode".

Go to the menu Alarm/Clean by using the ▲ or ▼ key.

Press the [ENTER] key to select this menu.

This Menu allows the configuration of Alarm and Clean functionality.

8.5.1 Alarm

To select "Setup Alarm", press the ▲ or ▼ key so that "Alarm" is flashing.

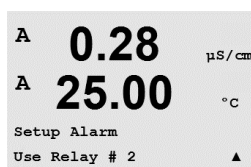

Using the ◀ and ▶ buttons, navigate to "Use Relay #". Using the ▲ or ▼ keys, select a relay to be used for the Alarm and press [ENTER].

One of the following events may be alarmed:

1. Power Failure
2. Software Failure
3. Rg Diagnostics – pH glass membrane resistance
4. Channel A disconnected
5. Channel B disconnected (only for 2-channel version)

If any of these criteria are set to Yes and the conditions for an alarm are given, the flashing symbol will be shown in the display, an alarm message will be recorded (see section 11.1 "Messages"; PATH: Info/Messages) and the selected relay will be activated. Furthermore an alarm can be indicated by the current output if this has been parameterized (see section 8.4 "Setpoints"; PATH: Menu/Configure/Analog Outputs).

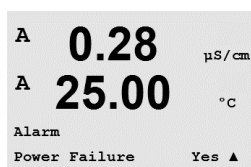

The conditions for alarms are:

1. there is a power failure or power cycling
2. the software watchdog performs a reset
3. Rg is out of tolerance – for example, broken measuring electrode (pH only)
4. If no sensor is connected on channel A
5. If no sensor is connected on channel B (only for 2-channel version)

For 1 and 2 the alarm indicator will be turned off when the alarm message is cleared. It will reappear if the power is constantly cycling or if the watchdog is repeatedly resetting the system.

Please note, that there are additional alarms, which will be indicated in the display. See section 13 "Troubleshooting".

Only for pH sensors

For 3 the alarm indicator will go off if the message is cleared and the sensor has been replaced or repaired so that the Rg value is within specification. If the Rg message is cleared and Rg is still out of tolerance then the alarm will stay on and the message will reappear. The Rg alarm can be turned off by going into this menu and setting Rg Diagnostics to No. The message can then be cleared and the alarm indicator will be off even though Rg is out of tolerance.

```

A 0.28 µS/cm
A 25.00 °C
Relay State = Inverted
R2 Delay = 001 sec ▲

```

Each Alarm Relay can be configured in either a Normal or Inverted state. In addition, a Delay for the activation can be set. For more information, refer to section 8.4 "Setpoints".

If power failure is turned on, only inverted state is possible and cannot be changed.

Pressing the [ENTER] key again will bring up the Save Changes dialog. Selecting No will discard the entered values, selecting Yes will make the entered values the current ones.

8.5.2 Clean

```

A 0.28 µS/cm
A 25.00 °C
Setup Clean
Use Relay # 1 ▲

```

Configure the Relay to be used for the cleaning cycle. The Default value is Relay 1.

```

A 0.28 µS/cm
A 25.00 °C
CleanInterval= 0.000 hrs
Clean Time = 0000 sec ▲

```

The Cleaning Interval can be set from 0.000 to 999.9 hours. Setting it to 0 turns the clean cycle off. The cleaning time can be 0 to 9999 seconds and must be smaller than the Cleaning Interval.

Select the desired Relay state: Normal or Inverted.

```

A 0.28 µS/cm
A 25.00 °C
Relay State = Normal ▲

```

Pressing the [ENTER] key again will bring up the Save Changes dialog. Selecting No will discard the entered values and return to the measurement display screen, selecting Yes will save changes made.

8.6 Display

(PATH: Menu/Configure/Display)

```

A 0.28 µS/cm
A 25.00 °C
Configure
Display ▲

```

Enter configuration mode as described in section 8.1 "Enter Configuration Mode".

This Menu allows for the configuration of the values to be displayed and also the configuration of the Display itself.

8.6.1 Measurement

The Display has 4 lines. Line 1 on top and Line 4 on the bottom.

Select the values (Measurement a, b, c or d) to be displayed on each line of the display.

```

A 0.28 µS/cm
A 25.00 °C
Display Setup
Measurement ▲

```

The selection of the values for a, b, c, d needs to be done under Configuration/Measurement/Channel Setup.

```

A 0.28 µS/cm
A 25.00 °C
Line 1 = a Line 2 = b
Line 3 = c Line 4 = d ▲

```

Select the "Error Display" mode. If this is set to "On" when an alarm has occurred, the message "Failure – Press Enter" will be displayed on Line 4 when an alarm occurs in the normal Measurement mode.



Pressing the [ENTER] key again will bring up the Save Changes dialog. Selecting No will discard the entered values, selecting Yes will make the entered values the current ones.

8.6.2 Resolution

This menu allows the setting of the resolution of each displayed value.

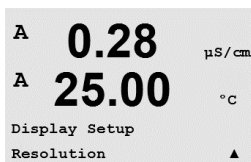

Possible settings are 1, 0.1, 0.01, 0.001 or Auto.

Pressing the [ENTER] key will bring up the Save Changes dialog.

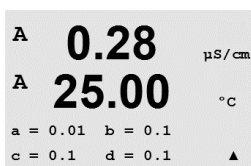

8.6.3 Backlight

This Menu allows the setting of the back light options of the display.

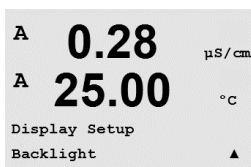

Possible settings are On, On 50% or Auto Off 50%. If Auto Off 50% is selected then the backlight will go to 50% after 4 minutes with no keypad activity. The backlight will automatically come back on if a key is pressed.

Pressing the [ENTER] key Will bring up the Save Changes dialog.



8.6.4 Name

This menu allows for the configuration of an alpha-numeric name which is displayed in the first 9 characters on Lines 3 and 4 of the Display. The default is nothing (blank).

If a name is entered on line 3 and/or 4 a measurement can be still displayed on the same line.

Use the ◀ and ▶ keys to navigate between digits to be altered. Using the ▲ and ▼ keys to change the character to be displayed. Once all digits of both display channels have been entered, press [ENTER] to bring up the Save Changes dialog.

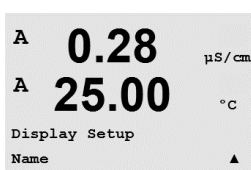

The resulting display in the measurement mode appears on Lines 3 and 4 ahead of the measurements.



8.7 Hold Analog Outputs

(PATH: Menu/Configure/Hold Outputs)

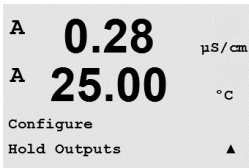

Enter configuration mode as described in section 8.1 "Enter Configuration Mode".

The **"Hold outputs"** function applies during the calibration process. If set "Hold outputs" to Yes, during calibration process the analog output, the output relay and USB output will be at hold state. The hold state depends on the setting. For the possible hold settings, see the list below. The following options are possible:

Hold Outputs? Yes/No

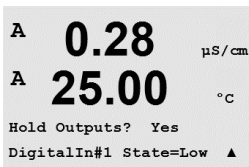

The **"DigitalIn"** function applies all the time. As soon as a signal is active on the digital input the transmitter goes to hold mode and the values on the analog output, the output relays and the USB output will be at hold state.

DigitalIn1/2* State = Off/Low/High



NOTE: DigitalIn1 is to hold channel A
DigitalIn2 is to hold channel B*

* Only on 2-channel version.

Possible Hold states:

Output relays:	On/Off	(Configuration/Set point)
Analog Output:	Last/Fixed	(Configuration/Analog output)
USB:	Last/Off	(System/USB)

9 System

(PATH: Menu/System)

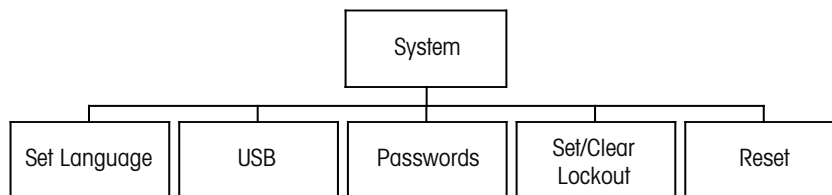

While in Measurement mode press the ◀ key. Press the ▼ or ▲ key to navigate to “System” – Menu and press [ENTER].

9.1 Set Language

(PATH: Menu/System/Set Language)

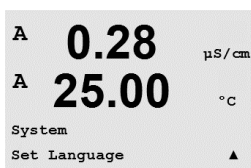

This Menu allows the configuration of the Display language.

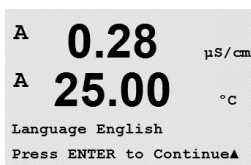

The following selections are possible:
English, French, German, Italian, Spanish, Russian, Portuguese and Japanese.
Pressing the [ENTER] key will bring up the Save Changes dialog.

9.2 USB

(PATH: Menu/System/USB)

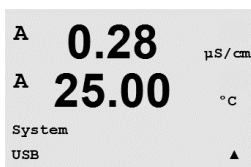

This menu allows configuration of the USB hold function.

USB Hold may be set to either Off or Last Values. An external host device may poll the M200 for data. If the USB Hold is set to Off, current values are returned. If the USB Hold is set to Last Values, the values present at the time the hold condition was established are returned.



Press [ENTER] to bring up the Save Changes dialog.

9.3 Passwords

(PATH: Menu/System/Passwords)

This Menu allows for the configuration of Operator and Administrator Passwords, as well as setting up a List of allowed Menus for the Operator. The Administrator has rights to access all Menu. All default passwords for new transmitters are "00000".

```
A 0.28 μS/cm
A 25.00 °C
System
Passwords ▲
```

The Passwords Menu is protected: Enter the Administrator Password to enter the Menu.

```
A 0.28 μS/cm
A 25.00 °C
Enter Password 00000
Change Administrator ▲
```

9.3.1 Changing Passwords

See section 9.3 "Passwords" on how to enter the Passwords Menu. Select Change Administrator or Change Operator and set the new Password.

```
A 0.28 μS/cm
A 25.00 °C
Change Administrator
New Password = 00000 ▲
```

Press the [ENTER] key and confirm the new password. Press [ENTER] again to bring up the Save Changed dialog.

```
A 0.28 μS/cm
A 25.00 °C
Re-enter password
New Password = 00000 ▲
```

9.3.2 Configuring Menu Access for Operator

See section 9.3 "Passwords" on how to enter the Passwords Menu. Select Configure Operator to configure the Access list for the Operator. It is possible to assign/deny rights to the following Menus: Cal Key, Quick Setup, Configuration, System and Service.

```
A 0.28 μS/cm
A 25.00 °C
Enter Password 00000
Configure Operator ▲
```

Choose either Yes or No to give/deny access to the above Menu and press [ENTER] to advance to the next items. Pressing the [ENTER] key after configuring all menus will bring up the Save Changes dialog. Selecting No will discard the entered values, selecting Yes will make the entered values the current ones.

```
A 0.28 μS/cm
A 25.00 °C
Cal Key Yes
Quick Setup Yes ▲
```

9.4 Set/Clear Lockout

(PATH: Menu/System/Set/Clear Lockout)

This menu enables/disables the Lockout functionality of the transmitter. The user will be asked for a password before being allowed into any menus if the Lockout functionality is enabled.

```
A 0.28 μS/cm
A 25.00 °C
System
Set/Clear Lockout ▲
```

```
A 0.28 μS/cm
A 25.00 °C
Password = 00000
Enable Lockout = Yes ▲
```

The Lockout – Menu is protected: Enter the Administrator Password and select YES to enable or NO to disable the Lockout functionality. Pressing the [ENTER] key after the selection will bring up the Save Changes dialog. Selecting No will discard the entered value, selecting Yes will make the entered value the current one.

9.5 Reset

(PATH: Menu/System/Reset)

This Menu allows access to the following options:
Reset System, Reset Analog Cal.

```
A 0.28 μS/cm
A 25.00 °C
System
Reset ▲
```

9.5.1 Reset System

This Menu allows the reset of the meter to the factory default settings (Setpoints off, analog outputs off, etc.). The meter calibration and the analog output calibration are not affected.

```
A 0.28 μS/cm
A 25.00 °C
Reset System ? Yes
Press ENTER to Continue▲
```

```
A 0.28 μS/cm
A 25.00 °C
Reset System
Are you sure? Yes ▲
```

Pressing the [ENTER] key after the selection will bring up a confirmation screen. Selecting No will return the user to the Measurement mode with no changes. Selecting Yes will reset the meter.

9.5.2 Reset Analog Calibration

This Menu allows reset of the Analog Output calibration factors to the last factory calibration values.

```
A 0.28 μS/cm
A 25.00 °C
Reset Analog Cal? Yes
Press ENTER to Continue▲
```

```
A 0.28 μS/cm
A 25.00 °C
Reset Analog Calibration
Are you sure? Yes ▲
```

Pressing the [ENTER] key after the selection will bring up a confirmation screen. Selecting No will return the user to the Measurement mode with no changes. Selecting Yes will reset the Analog Output calibration.

10 Service

(PATH: Menu/Service)

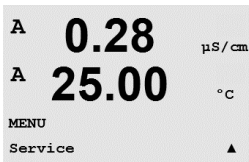
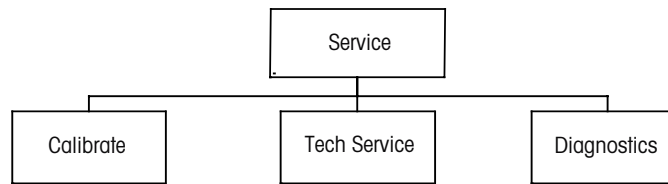

While in Measurement mode press the ◀ key. Press the ▲ or ▼ key to navigate to the “Service” Menu and press [ENTER]. The available system configuration options are detailed below

10.1 Diagnostics

(PATH: Menu/Service/Diagnostics)

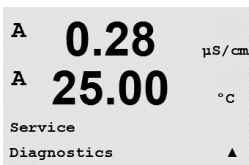

This Menu is a valuable tool for troubleshooting and provides diagnostic functionality for the following items: Model/Software Revision, Digital Input, Display, Keypad, Memory, Set Relays, Read Relays, Set Analog Outputs, Read Analog Outputs.

10.1.1 Model/Software Revision

Essential information for every Service call is the model and software revision number. This Menu shows the transmitter part number, serial number and software version number.

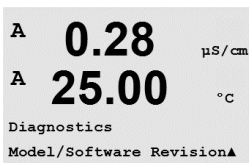

By using the ▼ key it is possible to navigate forward through this submenu and get additional information like the current version of software implemented on the transmitter: Master V_XXXX and Comm V_XXXX); and the version of the sensor firmware (FW V_XXX) and sensor hardware (HW XXXX).

Press [ENTER] to exit from this display.

10.1.2 Digital Input

The digital Input menu shows the state of the digital inputs. Press [ENTER] to exit from this display.

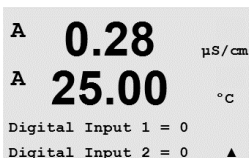
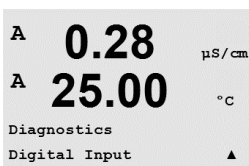

10.1.3 Display

All pixels of the display will be lit for 15 seconds to allow troubleshooting of the display. After 15 seconds the transmitter will return to the normal Measuring mode or press [ENTER] to exit sooner.

```
A 0.28 µS/cm
A 25.00 °C
Diagnostics
Display ▲
```

10.1.4 Keypad

For keypad diagnostics, the display will indicate which key is pressed. Pressing [ENTER] will return the transmitter to the normal Measuring mode.

```
A 0.28 µS/cm
A 25.00 °C
Diagnostics
Keypad ▲
```

```
A 0.28 µS/cm
A 25.00 °C
Key press =(MENU )
Press ENTER to Continue
```

10.1.5 Memory

If Memory is selected then the transmitter will perform a RAM and ROM memory test. Test patterns will be written to and read from all RAM memory locations. The ROM checksum will be recalculated and compared to the value stored in the ROM.

```
A 0.28 µS/cm
A 25.00 °C
Diagnostics
Memory ▲
```

```
A 0.28 µS/cm
A 25.00 °C
Memory Test Passed
Press ENTER to Continue
```

10.1.6 Set Relay

The Set Relays diagnostic menu allows for the activation/deactivation of each Relay.

0 = Normal (normally open contacts are open)
1 = Inverted (normally open contacts are closed)

Press [ENTER] to return to Measurement mode.

```
A 0.28 µS/cm
A 25.00 °C
Diagnostics
Set Relays ▲
```

```
A 0.28 µS/cm
A 25.00 °C
Relay1 = 0 Relay2 = 0
Relay3 = 0 Relay4 = 0 ▲
```

10.1.7 Read Relays

The Read Relays diagnostic menu shows the state of each Relay as defined below. Press [ENTER] to exit from this display.

0 = Normal
1 = Inverted.

```
A 0.28  μS/cm
A 25.00 °C
Diagnostics
Read Relays ▲
```

```
A 0.28  μS/cm
A 25.00 °C
Relay1 = 0 Relay2 = 0
Relay3 = 0 Relay4 = 0
```

10.1.8 Set Analog Outputs

This menu enables the user to set all analog outputs to any mA value within the 0–22 mA range. Press [ENTER] to exit from this display.

```
A 0.28  μS/cm
A 25.00 °C
Diagnostics
Set Analog Outputs ▲
```

```
A 0.28  μS/cm
A 25.00 °C
Analog out1 = 04.0 mA
Analog out2 = 04.0 mA ▲
```

10.1.9 Read Analog Outputs

This menu shows the mA value of the analog Outputs. Press [ENTER] to exit from this display.

```
A 0.28  μS/cm
A 25.00 °C
Diagnostics
Read Analog Outputs ▲
```

```
A 0.28  μS/cm
A 25.00 °C
Analog out1 = 20.5 mA
Analog out2 = 20.5 mA ▲
```

10.2 Calibrate

(PATH: Menu/Service/Calibrate)

This menu has the options to calibrate and the analog outputs and also allows the unlocking of calibration functionality.

```
A 0.28  μS/cm
A 25.00 °C
Service
Calibrate ▲
```

10.2.1 Calibrate Analog

Select the Analog Output you wish to calibrate. Each Analog output can be calibrated at 4 and 20 mA.

```
A 0.28  μS/cm
A 25.00  °C
Calibrate Analog
Analog Output 1 ▲
```

Connect an accurate milliamp meter to the Analog output terminals and then adjust the five digit number in the display until the milliamp meter reads 4.00 mA and repeat for 20.00 mA.

```
A 0.28  μS/cm
A 25.00  °C
Aout1 20mA Set 45000
Press ENTER when Done ▲
```

As the five digit number is increased the output current increases and as the number is decreased the output current decreases. Thus coarse changes in the output current can be made by changing the thousands or hundreds digits and fine changes can be made by changing the tens or ones digits.

```
A 0.28  μS/cm
A 25.00  °C
Aout1 4mA Set 08800
Press ENTER when Done ▲
```

Pressing the [ENTER] key after entering both values will bring up a confirmation screen. Selecting No will discard the entered values, selecting Yes will make the entered values the current ones.

```
A 0.28  μS/cm
A 25.00  °C
Save Calibration Yes
Press ENTER to Exit ▲
```

10.2.2 Calibrate Unlock

Select this Menu to configure the CAL Menu (see section 7 "Sensor Calibration").

```
A 0.28  μS/cm
A 25.00  °C
Calibrate Unlock
```

Selecting Yes means that Meter and Analog Output calibration Menus will be selectable under the CAL Menu. Selecting No means that only the Sensor calibration is available under the CAL Menu. Press [ENTER] after the selection to display a confirmation screen.

```
A 0.28  μS/cm
A 25.00  °C
Unlock Calibration Yes
Press ENTER to Continue▲
```

10.3 Tech Service

(PATH: Menu/Tech Service)



Note: This Menu is for Mettler Toledo Service personnel use only.

11 Info

(PATH: Info)

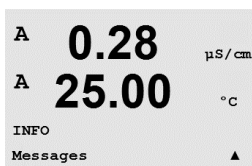
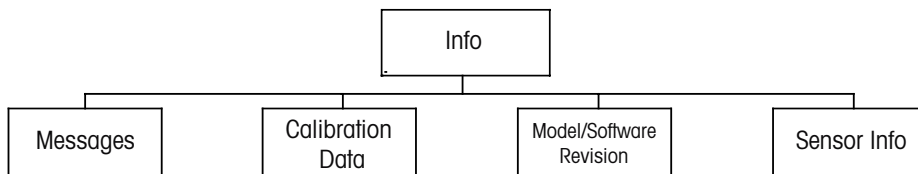

Pressing the ▼ key will display the Info Menu with the options Messages, Calibration Data and Model/Software Revision.

11.1 Messages

(PATH: Info/Messages)

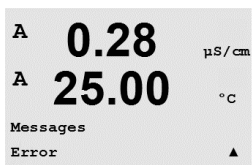

The most recent message is displayed. The up and down arrow keys allow scrolling through the last four messages that have occurred.



Clear Messages clears all the messages. Messages are added to the message list when the condition that generates the message first occurs. If all messages are cleared and a message condition still exists and started before the clear then it will not appear in the list. For this message to re-occur in the list the condition must go away and then reappear.

11.2 Calibration Data

(PATH: Info/Calibration Data)

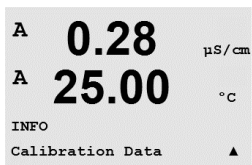

Selecting Calibration Data displays the calibration constants for each sensor. Use the up and down arrow keys to toggle between channels "A" and "B".

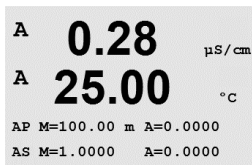

P = calibration constants for the primary measurement
 S = calibration constants for the secondary measurement

Press [ENTER] to exit from this display.

11.3 Model/Software Revision

```

A  0.28  μS/cm
A  25.00  °C
INFO
Model/Software Revision▲
  
```

Selecting Model/Software Revision will display the part number, model and the serial number of the transmitter and information about the connected sensor(s).

By using the ▼ key it is possible to navigate forward through this submenu and get additional information like the current version of software implemented on the transmitter:

Master V_XXXX and Comm V_XXXX; and the version of the sensor firmware (FW V_XXX) and sensor hardware (HW XXXX).

```

A  0.28  μS/cm
A  25.00  °C
PN xxxxxxxx Vx.xx
SN xxxxxxxxxx
  
```

The displayed information is important for any Service call. Press [ENTER] to return to the normal measurement mode.

11.4 Sensor Info

```

B  7.00  pH
B  25.0  °C
INFO
ISM Sensor Info ↑
  
```

After plugging in a sensor, the following information about the sensor will be shown in this menu. Use up and down arrows to scroll in the menu.

```

A  7.00  pH
A  25.0  °C
ChA Type: InPro3200 ↑
  
```

Type: Type of sensor

Cal Date*: Date of the last adjustment

Serial-No.: Serial number of the connected Sensor

Part-No.: Part number of the connected Sensor

* After connecting an ISM sensor

12 Maintenance

12.1 Front Panel Cleaning

Clean the front panel with a damp soft cloth (water only, no solvents). Gently wipe the surface and dry with a soft cloth.

13 Troubleshooting

If the equipment is used in a manner not specified by Mettler-Toledo, the protection provided by the equipment may be impaired.

Review the table below for possible causes of common problems:

Problem	Possible Cause
Display is blank.	<ul style="list-style-type: none"> – No power to M200. – Blown fuse. – LCD display contrast set incorrectly. – Hardware failure.
Incorrect measurement readings.	<ul style="list-style-type: none"> – Sensor improperly installed. – Incorrect units multiplier entered. – Temperature compensation incorrectly set or disabled. – Sensor needs calibration. – Sensor or patch cord defective or exceeds recommended maximum length. – Hardware failure.
Measurement readings not stable.	<ul style="list-style-type: none"> – Sensors or cables installed too close to equipment that generates high level of electrical noise. – Recommended cable length exceeded. – Averaging set too low. – Sensor or patch cord defective.
Displayed  is flashing.	<ul style="list-style-type: none"> – Setpoint is in alarm condition (setpoint exceeded). – Alarm has been selected (see chapter 8.5 Alarm/Clean) and occurred.
Cannot change menu settings.	<ul style="list-style-type: none"> – User locked out for security reasons.

13.1 Cond (Resistivity) Error Messages / Warning- and Alarm List

Alarms	Description
Watchdog time-out	SW/System fault

13.2 Oxygen Error Messages / Warning- and Alarm List

Warnings	Description
Warning O ₂ Slope < -90 nA	Slope too big
Warning O ₂ Slope > -35 nA	Slope too small
Warning O ₂ ZeroPt > 0.3 nA	Zero offset too big
Warning O ₂ ZeroPt < -0.3 nA	Zero offset too small

Alarms	Description
Watchdog time-out	SW/System fault
Error O ₂ Slope < -110 nA	Slope too big
Error O ₂ Slope > -30 nA	Slope too small
Error O ₂ ZeroPt > 0.6 nA	Zero offset too big
Error O ₂ ZeroPt < -0.6 nA	Zero offset too small

13.3 pH Error Messages / Warning- and Alarm List

Warnings	Description
Warning pH slope > 102%	Slope too big
Warning pH Slope < 90%	Slope too small
Warning pH Zero ± 0.5 pH	Out of range
Warning pHGs change < 0.3	Glass electrode resistance changed by less than factor 0.3
Warning pHGs change > 3	Glass electrode resistance changed by more than factor 3

Alarms	Description
Watchdog time-out	SW/System fault
Error pH Slope > 103%	Slope too big
Error pH Slope < 80%	Slope too small
Error pH Zero ± 1.0 pH	Out of range
Error pH Gls Res > 2000 MΩ	Glass electrode resistance too big (break)
Error pH Gls Res < 5 MΩ	Glass electrode resistance too small (short)

13.4 ORP Error Messages / Warning- and Alarm List

Warnings	Description
Warning ORP ZeroPt > 30 mV	Zero offset too big
Warning ORP ZeroPt < -30 mV	Zero offset too small

Alarms	Description
Watchdog time-out	SW/System fault
Error ORP ZeroPt > 60 mV	Zero offset too big
Error ORP ZeroPt < -60 mV	Zero offset too small

13.5 Warning- and Alarm Indication on the Display

13.5.1 Warning Indication

If there are conditions, which generate a warning, the message will be recorded and can be selected through the menu point Messages (PATH: Info/Messages; see also chapter Messages). According to the parameterisation of the transmitter the hint "Failure – Press Enter" will be shown at line 4 of the display if a warning or alarm has occurred (see also section 8.6 "Display"; PATH: Menu/Configure/Display/Measurement).

13.5.2 Alarm Indication

Alarms will be shown in the display by a flashing symbol and recorded through the menu point Messages (PATH: Info/Messages; see also section 11.1 "Messages").

Furthermore the detection of some alarms can be activated or deactivated (PATH: Menu/Configure/Alarm/Clean) for an indication on the display. If one of these alarms occurs and the detection has been activated, also a flashing symbol will be shown on the display and the message will be recorded through the menu point Messages (PATH: Info/Messages; see also section 11.1 "Messages").

Alarms, which are caused by a violation of the limitation of a setpoint or the range (see chapter 8.4 "Setpoints"; PATH: Menu/Configure/Setpoint) will also be shown by a flashing symbol and recorded through the menu point Messages (PATH: Info/Messages; see also section 11.1 "Messages").

According to the parameterization of the transmitter the hint "Failure – Press Enter" will be shown at line 4 of the display if a warning or alarm has occurred (see also section 8.6 "Display"; PATH: Menu/Configure/Display/Measurement).

14 Accessories and Spare Parts

Please contact your local Mettler-Toledo Sales office or representative for details for additional accessories and spare parts.

For M200

Description	Order no.
Pipe Mount Kit for 1/2DIN models	52 500 212
Panel Mount Kit for 1/2DIN models	52 500 213
Protective Hood for 1/2DIN models	52 500 214
Terminal blocks for M200, M300, M400	52 121 504

15 Specifications

15.1 General Specifications

pH/ORP (incl. pH/pNa)

Measurement parameters	pH, mV and temperature
pH display range	-2.00 to + 16.00 pH
pH resolution	Auto/0.001/0.01/0.1/1 (can be selected)
pH accuracy ¹⁾	± 1 digit
mV range	- 1500 to + 1500 mV
mV resolution	Auto/0.001/0.01/0.1/1 mV (can be selected)
mV accuracy ¹⁾	± 1 digit
Temperature measuring range	-30 to 130 °C (-22 to 266 °F)
Temperature resolution	Auto/0.001/0.01/0.1/1 (can be selected)
Temperature accuracy ¹⁾	± 1 digit
Temperature compensation	Automatic/Manual
Max. sensor cable length	80 m (260 ft)
Calibration	<ul style="list-style-type: none"> • pH: 1-point (offset), 2-point (slope and offset) or process (offset) • ORP: 1-point (offset)

1) ISM input signal causes no additional error.

Amperometric oxygen

Measurement parameters	Dissolved oxygen (DO) saturation or concentration and temperature
Measuring current range	0 to 900 nA
DO display ranges	<ul style="list-style-type: none"> • Saturation: 0 to 500 % air, 0 to 200 % O₂ sat • Concentration: 0.0 ppb (µg/L) to 50.00 ppm (mg/L)
DO accuracy	± 1 digit
DO Resolution	Auto/0.001/0.01/0.1/1 (can be selected)
Polarization voltage	-674 mV
Temperature measuring range	- 10 to +80 °C (+ 14 to + 176 °F)
Temperature resolution	Auto/0.001/0.01/0.1/1 (can be selected)
Temperature accuracy	± 1 digit
Temperature repeatability	± 1 digit
Temperature compensation	Automatic
Max. sensor cable length	80 m (260 ft)
Calibration	1-point (slope and offset) or process (slope and offset)

Dissolved ozone

Measurement parameters	Concentration and temperature
Display range for current	0 to –900 nA
Ozone display range	Concentration 0.1 ppb ($\mu\text{g/L}$) to 5.00 ppm (mg/L) O_3
Ozone accuracy	± 1 digit
Resolution current	± 1 digit
Temperature compensation	Automatic
Temperature display range	–30 to +150 °C (–22 to +302 °F)
Temperature resolution	Auto/0.001/0.01/0.1/1 (can be selected)
Temperature accuracy	± 1 digit
Max. sensor cable length	80 m
Calibration	1-point (offset) or process (slope or offset)

Conductivity 2-e/4-e

Measurement parameters	Conductivity/resistivity and temperature
Conductivity display ranges 2-electrode sensor	C = 0.01 0.002 to 500 $\mu\text{S/cm}$ (2000 $\Omega \times \text{cm}$ to 500 $\text{M}\Omega \times \text{cm}$)
	C = 0.1 0.02 to 50,000 $\mu\text{S/cm}$ (20 $\Omega \times \text{cm}$ to 50 $\text{M}\Omega \times \text{cm}$)
Conductivity display ranges 4-electrode sensor	0.01 to 1000 mS/cm (1.0 $\Omega \times \text{cm}$ to 0.1 $\text{M}\Omega \times \text{cm}$)
Chemical concentration curves	<ul style="list-style-type: none"> • NaCl: 0–26% @ 0 °C to 0–28% @ +100 °C • NaOH: 0–12% @ 0 °C to 0–16% @ +40 °C to 0–6% @ +100 °C • HCl: 0–18% @ –20 °C to 0–18% @ 0 °C to 0–5% @ +50 °C • HNO_3: 0–30% @ –20 °C to 0–30% @ 0 °C to 0–8% @ +50 °C • H_2SO_4: 0–26% @ –12 °C to 0–26% @ +5 °C to 0–9% @ +100 °C • H_3PO_4: 0–35% @ +5 °C to +80 °C
TDS ranges	NaCl and CaCO_3
Cond/Res accuracy ¹⁾	± 1 digit
Cond/Res repeatability ¹⁾	± 1 digit
Cond/Res resolution	Auto/0.001/0.01/0.1/1 (can be selected)
Temperature display range	–40 to +200 °C (–40 to +392 °F)
Temperature resolution	Auto/0.001/0.01/0.1/1 (can be selected)
Temperature accuracy	± 1 digit
Max. sensor cable length	<ul style="list-style-type: none"> • 2-e sensors: 90 m (300 ft) • 4-e sensors: 80 m (260 ft)
Calibration	1-point (offset), 2-point (slope and offset) or process (slope)

15.2 Electrical Specifications

Supply voltage	<ul style="list-style-type: none"> • 100 to 240 V AC, 50 to 60 Hz, 10 VA • 20 to 30 V DC, 10 VA
Connection terminal	Detachable screw terminals, appropriate for wire cross section 0.2 to 1.5 mm ² (AWG 16 – 24)
Mains fuse	1.0 A slow blow, type FC
Number of analog outputs	<ul style="list-style-type: none"> • 4 for 2-channel version • 2 for 1-channel version
Analog output signals	0 / 4 to 20 mA, 22 mA alarm, galvanically isolated from input and from earth / ground
Measurement error through analog outputs	<ul style="list-style-type: none"> < ±0.05 mA over 1 to 22 mA range < ±0.10 mA over 0 to 1 mA range
Analog output configuration	Linear
Load	Max. 500 Ω
Hold input/Alarm contact	Yes/Yes
Alarm output delay	0 to 999 s
Relays	2 SPDT, mechanical, rated at 250 V AC, 3 Amps
Digital input	<ul style="list-style-type: none"> • 2 for 2-channel version • 1 for 1-channel version Galvanically isolated from output and ground / earth
Display	Backlit LCD, 4 lines
Keypad	5 tactile feedback keys
Languages	8 (English, German, French, Italian, Spanish, Portuguese, Russian and Japanese)
Digital communication	USB, Type B connector

15.3 Mechanical Specifications

15.3.1 Mechanical Specifications for 1/2DIN Version

Dimensions	Housing – Height x Width x Depth	144 x 144 x 116 mm (5.7 x 5.7 x 4.6 inch)
	Front bezel – Height x Width	150 x 150 mm (5.9 x 5.9 inch)
	Max. depth – panel mounted	87 mm (excludes plug-in connectors)
Weight		0.95 kg (2 lb)
Material		ABS / Polycarbonate
Enclosure rating		IP 65

15.3.2 Mechanical Specifications for 1/4DIN Version

Dimensions	Housing –	90 x 90 x 126 mm
	Height x Width x Depth	(3.54 x 3.54 x 4.96)
	Front bezel –	102 x 102 mm
	Height x Width	(4.02 x 4.02 inch)
	Max. depth –	126 mm
	panel mounted	(excludes plug-in connectors)
Weight		0.6 kg (1.5 lb)
Material		ABS / Polycarbonate
Enclosure rating		IP 65 (front) / IP 20 (housing)

15.4 Environmental Specifications

Storage temperature	–40 to +70 °C (–40 to +158 °F)
Ambient temperature operating range	–10 to +50 °C (+14 to +122 °F)
Relative humidity	0 to 95 % non-condensing
EMC	Compliant with EN 61326-1:2013 (Industrial environment) Emission: Class B, Immunity: Class A
UL	Installation (overvoltage) Category II
CE mark	The measuring system is in conformity with the statutory requirements of the EC Directives. METTLER TOLEDO confirms successful testing of the device by affixing to it the CE mark.

16 Default Tables

16.1 M200 (1-channel Version)

Parameter	Sub parameter	Value	Unit
Alarm	relay	2	
	diagnostics	No	
	power failure	No	
	software failure	No	
	Disconnect ChA	No	
	Hold mode*	Last	
	delay	1	sec
	hysteresis	0	
	state	inverted	
Clean	relay	1	
	hold mode*	Last	
	Interval	0	Hrs
	clean time	0	Sec
	state	normal	
	delay	0	
	hysteresis	0	
Language		English	
Passwords	administrator	00000	
	operator	00000	
Lockout	Yes/No	No	
Analog Out	1	a	
	2	b	
All analog out	mode	4–20 mA	
	type	normal	
	alarm	off	
	hold mode	last value	
Set point 1	measurement	a	
	type	off	
	high/low value	0	
	Relay	2	
Set point 2	measurement	b**	
	type	off	
	high/low value	0	
	Relay	2	
Set point 3	measurement	_(none)	
	type	off	
	high/low value	0	
	Relay	_(none)	
Set point 4	measurement	_(none)	
	type	off	
	high/low value	0	
	Relay	_(none)	
Relay 1		clean	
Relay 2		alarm, set point 1, set point 2	

* for analog output signal if relay is switched

** _ (none) if ORP sensor is connected

16.2 M200 (2-channel Version)

Parameter	Sub parameter	Value	Unit
Alarm	relay	2	
	diagnostics	No	
	power failure	No	
	software failure	No	
	Disconnect ChA	No	
	Disconnect ChB	No	
	hold mode*	Last	
	delay	1	sec
	hysteresis	0	
	state	inverted	
Clean	relay	1	
	hold mode*	Last	
	Interval	0	Hrs
	clean time	0	Sec
	state	normal	
	delay	0	
	hysteresis	0	
Language		English	
Passwords	administrator	00000	
	operator	00000	
Lockout	Yes/No	No	
Analog Out	1	a	
	2	b**	
	3	c	
	4	d**	
All analog out	mode	4–20 mA	
	type	normal	
	alarm	off	
	hold mode	last value	
Set point 1	measurement	a	
	type	off	
	high/low value	0	
	relay	2	
Set point 2	measurement	c	
	type	off	
	high / low value	0	
	relay	2	
Set point 3	Measurement	_(none)	
	Type	off	
	high / low value	0	
	relay	_(none)	
Set point 4	measurement	_(none)	
	type	off	
	high / low value	0	
	relay	_(none)	

Parameter	Sub parameter	Value	Unit
Set point 5	measurement	_(none)	
	type	off	
	high / low value	0	
	relay	_(none)	
Set point 6	measurement	_(none)	
	type	off	
	high / low value	0	
	relay	_(none)	
Relay 1		Clean	
Relay 2		Alarm, set point 2	

* for analog output signal if relay is switched

** _ (none) if ORP sensor is connected

16.3 Parameter Related Values

The transmitter recognizes the connected digital sensor, and loads different default values, depending on the type of digital sensor. In this chapter the default values are listed if a sensor is connected to channel A. If not otherwise mentioned, for the second channel (2-channel devices) the values are also valid.

16.3.1 Conductivity

Parameter	Sub parameter	Value	Unit
Analog Out	1	a – conductivity (resistivity)	μS/cm (MV-cm)
	2	a – temperature	°C
All analog out	mode	4–20 mA	
	type	normal	
	alarm	off	
	hold mode	last value	
Conductivity	value 4 mA	0.1 (10)	μS/cm (MV-cm)
	value 20 mA	10 (20)	μS/cm (MV-cm)
Temperature	value 4 mA	0	°C
	value 20 mA	100	°C
Set point 1	measurement	a	
	type	off	
	high value	00	μS/cm (MV-cm)
	low value	00	μS/cm (MV-cm)
	relay	1	
Set point 2	measurement	b (2nd channel: c)	
	type	off	
	high value	0 (0)	°C 2nd channel: μS/cm (MV-cm)
	low value	0 (0)	°C 2nd channel: μS/cm (MV-cm)
	relay	1	
Resolution	conductivity (resistivity)	0.01 (0.01)	μS/cm (MV-cm)
	temperature	0.1	°C

Values in parentheses: Default values if resistivity instead of conductivity is chosen.

16.3.2 Oxygen

Parameter	Sub parameter	Value	Unit
Analog Out	1	a – oxygen	% air
	2	a – temperature	°C
All analog out	mode	4–20 mA	
	type	normal	
	alarm	off	
	hold mode	last value	
Oxygen	value 4 mA	0	% air
	value 20 mA	100	% air
Temperature	value 4 mA	0	°C
	value 20 mA	100	°C
Set point 1	measurement	a	
	type	off	
	high value	50	% air
	low value	0	% air
	relay	1	
Set point 2	measurement	b (2nd channel: c)	
	type	off	
	high value	0 (2nd channel: 50)	°C (2nd channel: % air)
	low value	0 (2nd channel: 0)	°C (2nd channel: % air)
	relay	1	
Resolution	Oxygen	auto	% sat
		1.0	ppb
	Temperature	0.1	°C
V polarization*		+ 675	mV
CalPres		759.8	mmHg
ProcPres		759.8	mmHg
ProcCalPres		CalPres	
Salinity		0.0	g/Kg
Humidity		100	%

* not adjustable

16.3.3 pH

Parameter	Sub parameter	Value	Unit
pH Buffer		Mettler-9	
Analog Out	1	a – pH	
	2	a – temperature	°C
All analog out	Mode	4–20 mA	
	type	normal	
	alarm	off	
	hold mode	last value	
pH	value 4 mA	2	pH
	value 20 mA	12	pH
Temperature	value 4 mA	0	°C
	value 20 mA	100	°C
Set point 1	measurement	a	
	type	off	
	high value	12	pH
	low value	0	pH
	relay	1	
Set point 2	measurement	b (2nd channel: c)	
	type	off	
	high value	0 (2nd channel: 12)	°C (2nd channel: pH)
	low value	0 (2nd channel: 0)	°C (2nd channel: pH)
	relay	1	
Resolution	pH	0.01	pH
	Temperature	0.1	°C
Drift control		Auto	
IP		7.0	pH
STC		0.000	pH/°C
Fix CalTemp		No	

16.3.4 ORP

Parameter	Sub parameter	Value	Unit
Analog Out	1	a – ORP	mV ORP
	2	a – none	
All analog out	mode	4–20 mA	
	type	normal	
	alarm	off	
	hold mode	last value	
ORP	value 4 mA	–500	mV
	value 20 mA	+500	mV
Set point 1	measurement	a	
	type	off	
	high value	+500	mV
	low value	–500	mV
	relay	2	
Set point 2	measurement	none (2nd channel: c)	
	type	off	
	high value	none (2nd channel:+500)	(2nd channel: mV)
	low value	none (2nd channel:+500)	(2nd channel: mV)
	relay	2	
Resolution	ORP	auto	mV

16.3.5 Ozone

Parameter	Sub parameter	Value	Unit
Analog Out	1	a – O3	ppm O3
	2	a – temperature	°C
Cal constants		read from sensor	
All analog out	mode	4–20 mA	
	type	normal	
	alarm	off	
	hold mode	last value	
O3	value 4 mA	0.00	ppb
	value 20 mA	20.00	ppm
Temperature	value 4 mA	0	°C
	value 20 mA	100	°C
Set point 1	measurement	a	
	type	off	
	relay	1	
Set point 2	measurement	b (2nd channel: c)	
	type	off	
	relay	1	
Resolution	O3	0.1	ppm
	temperature	0.1	°C

17 Warranty

METTLER TOLEDO warrants this product to be free from significant deviations in material and workmanship for a period of one year from the date of purchase. If repair is necessary and not the result of abuse or misuse within the warranty period, please return by freight pre-paid and amendment will be made without any charge. METTLER TOLEDO's Customer Service Dept. will determine if the product problem is due to deviations or customer abuse. Out-of-warranty products will be repaired on an exchange basis at cost.

The above warranty is the only warranty made by METTLER TOLEDO and is lieu of all other warranties, expressed or implied, including, without limitation, implied warranties of merchantability and fitness for a particular purpose. METTLER TOLEDO shall not be liable for any loss, claim, expense or damage caused by, contributed to or arising out of the acts or omissions of the Buyer or Third Parties, whether negligent or otherwise. In no event shall METTLER TOLEDO's liability for any cause of action whatsoever exceed the cost of the item giving rise to the claim, whether based in contract, warranty, indemnity, or tort (including negligence).

18 Certificate

METTLER TOLEDO Thornton, Inc., 900 Middlesex Turnpike, Building 8, Billerica, MA 01821 USA has obtained Underwriters Laboratories' listing for M200 Model Transmitters. They bear the cULus Listed mark, signifying that the products have been evaluated to the applicable ANSI/UL and CSA Standards for use in the U.S. and Canada.

19 Buffer Tables

M200 transmitters have the ability to do automatic pH buffer recognition. The following tables show different standard buffers that are automatically recognized.

19.1 Mettler-9

Temp (°C)	pH of buffer solutions			
0	2.03	4.01	7.12	9.52
5	2.02	4.01	7.09	9.45
10	2.01	4.00	7.06	9.38
15	2.00	4.00	7.04	9.32
20	2.00	4.00	7.02	9.26
25	2.00	4.01	7.00	9.21
30	1.99	4.01	6.99	9.16
35	1.99	4.02	6.98	9.11
40	1.98	4.03	6.97	9.06
45	1.98	4.04	6.97	9.03
50	1.98	4.06	6.97	8.99
55	1.98	4.08	6.98	8.96
60	1.98	4.10	6.98	8.93
65	1.99	4.13	6.99	8.90
70	1.99	4.16	7.00	8.88
75	2.00	4.19	7.02	8.85
80	2.00	4.22	7.04	8.83
85	2.00	4.26	7.06	8.81
90	2.00	4.30	7.09	8.79
95	2.00	4.35	7.12	8.77

19.2 Mettler-10

Temp (°C)	pH of buffer solutions			
0	2.03	4.01	7.12	10.32
5	2.02	4.01	7.09	10.25
10	2.01	4.00	7.06	10.18
15	2.00	4.00	7.04	10.12
20	2.00	4.00	7.02	10.06
25	2.00	4.01	7.00	10.01
30	1.99	4.01	6.99	9.97
35	1.99	4.02	6.98	9.93
40	1.98	4.03	6.97	9.89
45	1.98	4.04	6.97	9.86
50	1.98	4.06	6.97	9.83
55	1.98	4.08	6.98	9.83
60	1.98	4.10	6.98	9.83
65	1.99	4.13	6.99	9.83
70	1.99	4.16	7.00	9.83
75	2.00	4.19	7.02	9.83
80	2.00	4.22	7.04	9.83
85	2.00	4.26	7.06	9.83
90	2.00	4.30	7.09	9.83
95	2.00	4.35	7.12	9.83

19.3 NIST Technical Buffers

Temp (°C)	pH of buffer solutions				
0	1.67	4.00	7.115	10.32	13.42
5	1.67	4.00	7.085	10.25	13.21
10	1.67	4.00	7.06	10.18	13.01
15	1.67	4.00	7.04	10.12	12.80
20	1.675	4.00	7.015	10.06	12.64
25	1.68	4.005	7.00	10.01	12.46
30	1.68	4.015	6.985	9.97	12.30
37	1.69	4.025	6.98	9.93	12.13
40	1.69	4.03	6.975	9.89	11.99
45	1.70	4.045	6.975	9.86	11.84
50	1.705	4.06	6.97	9.83	11.71
55	1.715	4.075	6.97	9.83*	11.57
60	1.72	4.085	6.97	9.83*	11.45
65	1.73	4.10	6.98	9.83*	11.45*
70	1.74	4.13	6.99	9.83*	11.45*
75	1.75	4.14	7.01	9.83*	11.45*
80	1.765	4.16	7.03	9.83*	11.45*
85	1.78	4.18	7.05	9.83*	11.45*
90	1.79	4.21	7.08	9.83*	11.45*
95	1.805	4.23	7.11	9.83*	11.45*

*Extrapolated

19.4 NIST Standard Buffers (DIN 19266: 2000–01)

Temp (°C)	pH of buffer solutions			
0				
5	1.668	4.004	6.950	9.392
10	1.670	4.001	6.922	9.331
15	1.672	4.001	6.900	9.277
20	1.676	4.003	6.880	9.228
25	1.680	4.008	6.865	9.184
30	1.685	4.015	6.853	9.144
35	1.694	4.028	6.841	9.095
40	1.697	4.036	6.837	9.076
45	1.704	4.049	6.834	9.046
50	1.712	4.064	6.833	9.018
55	1.715	4.075	6.834	8.985
60	1.723	4.091	6.836	8.962
70	1.743	4.126	6.845	8.921
80	1.766	4.164	6.859	8.885
90	1.792	4.205	6.877	8.850
95	1.806	4.227	6.886	8.833



NOTE: The pH(S) values of the individual charges of the secondary reference materials are documented in a certificate of an accredited laboratory. This certificate is supplied with the respective buffer materials. Only these pH(S) values shall be used as standard values for the secondary reference buffer materials. Correspondingly, this standard does not include a table with standard pH values for practical use. The table above only provides examples of pH(PS) values for orientation.

19.5 Hach Buffers

Buffer values up to 60 °C as specified by Bergmann & Beving Process AB.

Temp (°C)	pH of buffer solutions		
0	4.00	7.14	10.30
5	4.00	7.10	10.23
10	4.00	7.04	10.11
15	4.00	7.04	10.11
20	4.00	7.02	10.05
25	4.01	7.00	10.00
30	4.01	6.99	9.96
35	4.02	6.98	9.92
40	4.03	6.98	9.88
45	4.05	6.98	9.85
50	4.06	6.98	9.82
55	4.07	6.98	9.79
60	4.09	6.99	9.76
65	4.09*	6.99*	9.76*
70	4.09*	6.99*	9.76*
75	4.09*	6.99*	9.76*
80	4.09*	6.99*	9.76*
85	4.09*	6.99*	9.76*
90	4.09*	6.99*	9.76*
95	4.09*	6.99*	9.76*

*Values complemented

19.6 Ciba (94) Buffers

Temp (°C)	pH of buffer solutions			
0	2.04	4.00	7.10	10.30
5	2.09	4.02	7.08	10.21
10	2.07	4.00	7.05	10.14
15	2.08	4.00	7.02	10.06
20	2.09	4.01	6.98	9.99
25	2.08	4.02	6.98	9.95
30	2.06	4.00	6.96	9.89
35	2.06	4.01	6.95	9.85
40	2.07	4.02	6.94	9.81
45	2.06	4.03	6.93	9.77
50	2.06	4.04	6.93	9.73
55	2.05	4.05	6.91	9.68
60	2.08	4.10	6.93	9.66
65	2.07*	4.10*	6.92*	9.61*
70	2.07	4.11	6.92	9.57
75	2.04*	4.13*	6.92*	9.54*
80	2.02	4.15	6.93	9.52
85	2.03*	4.17*	6.95*	9.47*
90	2.04	4.20	6.97	9.43
95	2.05*	4.22*	6.99*	9.38*

*Extrapolated

19.7 Merck Titrisole, Riedel-de-Haën Fixanale

Temp (°C)	pH of buffer solutions				
0	2.01	4.05	7.13	9.24	12.58
5	2.01	4.05	7.07	9.16	12.41
10	2.01	4.02	7.05	9.11	12.26
15	2.00	4.01	7.02	9.05	12.10
20	2.00	4.00	7.00	9.00	12.00
25	2.00	4.01	6.98	8.95	11.88
30	2.00	4.01	6.98	8.91	11.72
35	2.00	4.01	6.96	8.88	11.67
40	2.00	4.01	6.95	8.85	11.54
45	2.00	4.01	6.95	8.82	11.44
50	2.00	4.00	6.95	8.79	11.33
55	2.00	4.00	6.95	8.76	11.19
60	2.00	4.00	6.96	8.73	11.04
65	2.00	4.00	6.96	8.72	10.97
70	2.01	4.00	6.96	8.70	10.90
75	2.01	4.00	6.96	8.68	10.80
80	2.01	4.00	6.97	8.66	10.70
85	2.01	4.00	6.98	8.65	10.59
90	2.01	4.00	7.00	8.64	10.48
95	2.01	4.00	7.02	8.64	10.37

19.8 WTW Buffers

Temp (°C)	pH of buffer solutions			
0	2.03	4.01	7.12	10.65
5	2.02	4.01	7.09	10.52
10	2.01	4.00	7.06	10.39
15	2.00	4.00	7.04	10.26
20	2.00	4.00	7.02	10.13
25	2.00	4.01	7.00	10.00
30	1.99	4.01	6.99	9.87
35	1.99	4.02	6.98	9.74
40	1.98	4.03	6.97	9.61
45	1.98	4.04	6.97	9.48
50	1.98	4.06	6.97	9.35
55	1.98	4.08	6.98	
60	1.98	4.10	6.98	
65	1.99	4.13	6.99	
70	2.00	4.16	7.00	
75	2.00	4.19	7.02	
80	2.00	4.22	7.04	
85	2.00	4.26	7.06	
90	2.00	4.30	7.09	
95	2.00	4.35	7.12	

Sales and Service:

Australia

Mettler-Toledo Limited
220 Turner Street
Port Melbourne, VIC 3207
Australia
Phone +61 1300 659 761
e-mail info.mtaus@mt.com

Austria

Mettler-Toledo Ges.m.b.H.
Laxenburger Str. 252/2
AT-1230 Wien
Phone +43 1 607 4356
e-mail prozess@mtf.com

Brazil

Mettler-Toledo Ind. e Com. Ltda.
Avenida Tamboré, 418
Tamboré
BR-06460-000 Barueri/SP
Phone +55 11 4166 7400
e-mail mtbr@mt.com

Canada

Mettler-Toledo Inc.
2915 Argenta Rd #6
CA-ON L5N 8G6 Mississauga
Phone +1 800 638 8537
e-mail ProlnsideSalesCA@mtf.com

China

Mettler-Toledo International Trading
(Shanghai) Co. Ltd.
589 Gui Ping Road
Cao He Jing
CN-200233 Shanghai
Phone +86 21 64 85 04 35
e-mail ad@mtf.com

Croatia

Mettler-Toledo d.o.o.
Mandlova 3
HR-10000 Zagreb
Phone +385 1 292 06 33
e-mail mt.zagreb@mtf.com

Czech Republic

Mettler-Toledo s.r.o.
Trebohosticka 2283/2
CZ-100 00 Praha 10
Phone +420 2 72 123 150
e-mail sales.mtcz@mtf.com

Denmark

Mettler-Toledo A/S
Naverland 8
DK-2600 Glostrup
Phone +45 43 27 08 00
e-mail info.mtdk@mtf.com

France

Mettler-Toledo
Analyse Industrielle S.A.S.
30, Boulevard de Douaumont
FR-75017 Paris
Phone +33 1 47 37 06 00
e-mail mtpro-f@mtf.com

Germany

Mettler-Toledo GmbH
Prozeßanalytik
Ockerweg 3
DE-35396 Gießen
Phone +49 641 507 444
e-mail prozess@mtf.com

Great Britain

Mettler-Toledo LTD
64 Boston Road, Beaumont Leys
GB-Leicester LE4 1AW
Phone +44 116 235 7070
e-mail enquire.mtuk@mtf.com

Hungary

Mettler-Toledo Kereskedelmi KFT
Teve u. 41
HU-1139 Budapest
Phone +36 1 288 40 40
e-mail mthu@axelero.hu

India

Mettler-Toledo India Private Limited
Amar Hill, Saki Vihar Road
Powai
IN-400 072 Mumbai
Phone +91 22 2857 0808
e-mail sales.mtin@mtf.com

Indonesia

PT. Mettler-Toledo Indonesia
GRHA PERSADA 3rd Floor
Jl. KH. Noer Ali No.3A,
Kayuringin Jaya
Kalimalang, Bekasi 17144, ID
Phone +62 21 294 53919
e-mail mt-id.customersupport@mtf.com

Italy

Mettler-Toledo S.p.A.
Via Vialba 42
IT-20026 Novate Milanese
Phone +39 02 333 321
e-mail customercare.italia@mtf.com

Japan

Mettler-Toledo K.K.
Process Division
6F Ikenohata Nisshoku Bldg.
2-9-7, Ikenohata
Taito-ku
JP-110-0008 Tokyo
Phone +81 3 5815 5606
e-mail helpdesk.ing.jp@mtf.com

Malaysia

Mettler-Toledo (M) Sdn Bhd
Bangunan Electrocon Holding, U 1-01
Lot 8 Jalan Astaka U8/84
Seksyen U8, Bukit Jelutong
MY-40150 Shah Alam Selangor
Phone +60 3 78 44 58 88
e-mail MT-MY.CustomerSupport@mtf.com

Mexico

Mettler-Toledo S.A. de C.V.
Ejército Nacional #340
Polanco V Sección
C.P. 11560
MX-México D.F.
Phone +52 55 1946 0900
e-mail mt.mexico@mtf.com

Norway

Mettler-Toledo AS
Ulvveien 92B
NO-0581 Oslo Norway
Phone +47 22 30 44 90
e-mail info.mtn@mtf.com

Poland

Mettler-Toledo (Poland) Sp.z.o.o.
ul. Poleczki 21
PL-02-822 Warszawa
Phone +48 22 545 06 80
e-mail polska@mtf.com

Russia

Mettler-Toledo Vostok ZAO
Sretenskij Bulvar 6/1
Office 6
RU-101000 Moscow
Phone +7 495 621 56 66
e-mail inforus@mtf.com

Singapore

Mettler-Toledo (S) Pte. Ltd.
Block 28
Ayer Rajah Crescent #05-01
SG-139959 Singapore
Phone +65 6890 00 11
e-mail mt.sg.customersupport@mtf.com

Slovakia

Mettler-Toledo s.r.o.
Hattalova 12/A
SK-831 03 Bratislava
Phone +421 2 4444 12 20-2
e-mail predaj@mtf.com

Slovenia

Mettler-Toledo d.o.o.
Pot heroja Trtnika 26
SI-1261 Ljubljana-Dobrunje
Phone +386 1 530 80 50
e-mail keith.racman@mtf.com

South Korea

Mettler-Toledo (Korea) Ltd.
1 & 4F, Yeil Building 21
Yangjaecheon-ro 19-gil
Seocho-Gu
Seoul 06753 Korea
Phone +82 2 3498 3500
e-mail Sales_MTKR@mtf.com

Spain

Mettler-Toledo S.A.E.
C/Miguel Hernández, 69-71
ES-08908 L'Hospitalet de Llobregat
(Barcelona)
Phone +34 902 32 00 23
e-mail mtemkt@mtf.com

Sweden

Mettler-Toledo AB
Virkesvägen 10
Box 92161
SE-12008 Stockholm
Phone +46 8 702 50 00
e-mail sales.mts@mtf.com

Switzerland

Mettler-Toledo (Schweiz) GmbH
Im Langacher, Postfach
CH-8606 Greifensee
Phone +41 44 944 47 60
e-mail ProSupport.ch@mtf.com

Thailand

Mettler-Toledo (Thailand) Ltd.
272 Soi Soonvijai 4
Rama 9 Rd., Bangkapi
Huay Kwang
TH-10320 Bangkok
Phone +66 2 723 03 00
e-mail MT-TH.CustomerSupport@mtf.com

Turkey

Mettler-Toledo Türkiye
Haluk Türksöy Sokak No: 6 Zemin ve 1.
Bodrum Kat 34662 Üsküdar-Istanbul, TR
Phone +90 216 400 20 20
e-mail sales.mtr@mtf.com

USA

METTLER TOLEDO
Process Analytics
900 Middlesex Turnpike, Bld. 8
Billerica, MA 01821, USA
Phone +1 781 301 8800
Freephone +1 800 352 8763
e-mail mtprou@mtf.com

Vietnam

Mettler-Toledo (Vietnam) LLC
29A Hoang Hoa Tham Street, Ward 6
Binh Thanh District
Ho Chi Minh City, Vietnam
Phone +84 8 35515924
e-mail MT-VN.CustomerSupport@mtf.com



Management System
certified according to
ISO 9001 / ISO 14001

Subject to technical changes.
© Mettler-Toledo GmbH, Process Analytics
03/2016 Printed in Switzerland. 30 300 227

Mettler-Toledo GmbH, Process Analytics
Im Hackacker 15, CH-8902 Urdorf, Switzerland
Tel. +41 44 729 62 11, Fax +41 44 729 66 36

www.mt.com/pro