

Shipping Scale

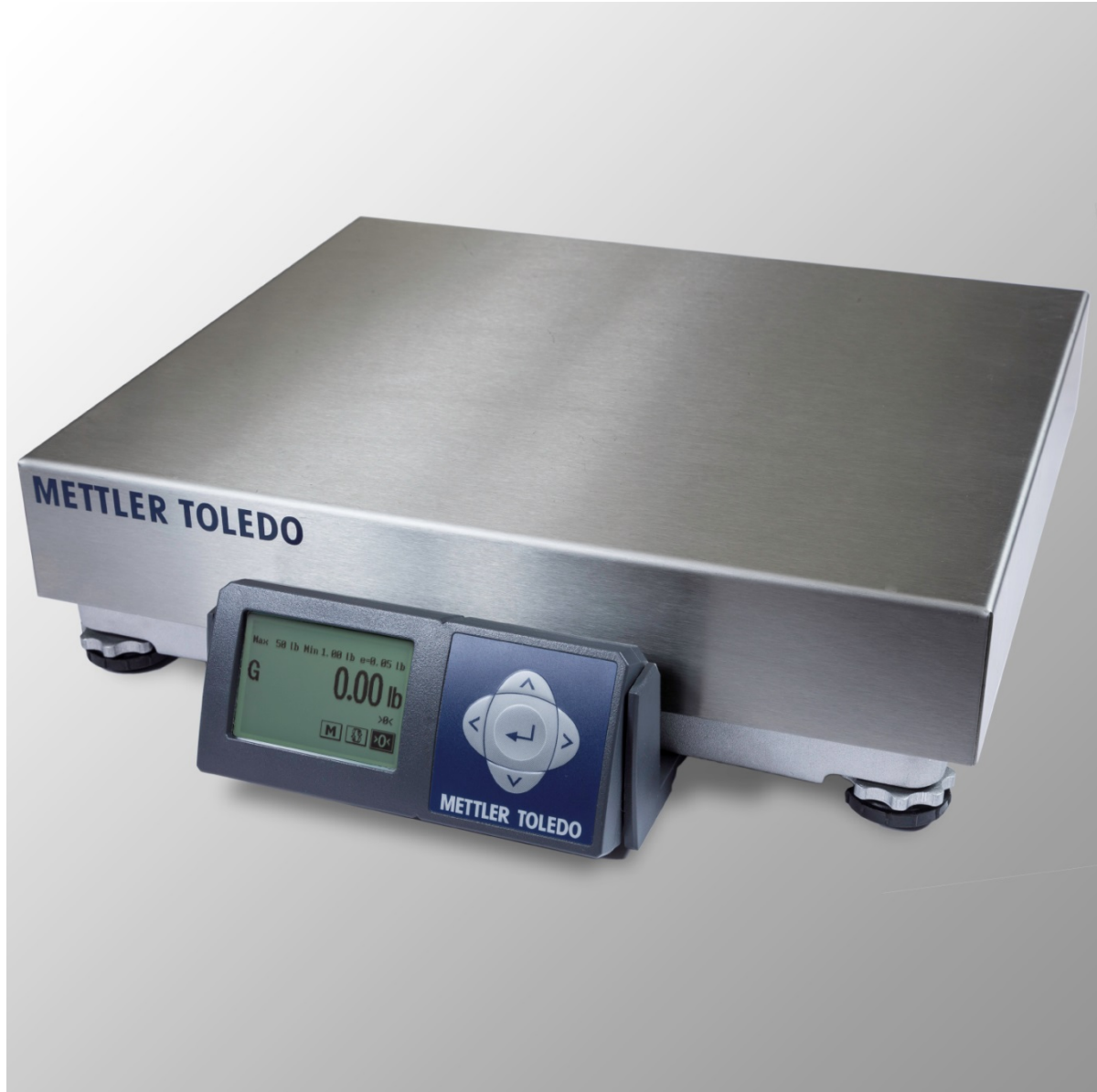

BC Shipping Scale

METTLER TOLEDO Service

Essential Services for Dependable Performance of Your BC Shipping Scale

Congratulations on choosing the quality and precision of METTLER TOLEDO. Proper use of your new equipment according to this Manual and regular calibration and maintenance by our factory-trained service team ensures dependable and accurate operation, protecting your investment. Contact us about a service agreement tailored to your needs and budget. Further information is available at www.mt.com/service.

There are several important ways to ensure you maximize the performance of your investment:

1. **Register your product:** We invite you to register your product at www.mt.com/productregistration so we can contact you about enhancements, updates and important notifications concerning your product.
2. **Contact METTLER TOLEDO for service:** The value of a measurement is proportional to its accuracy – an out of specification scale can diminish quality, reduce profits and increase liability. Timely service from METTLER TOLEDO will ensure accuracy and optimize uptime and equipment life.
 - a. **Installation, Configuration, Integration and Training:** Our service representatives are factory-trained, weighing equipment experts. We make certain that your weighing equipment is ready for production in a cost effective and timely fashion and that personnel are trained for success.
 - b. **Initial Calibration Documentation:** The installation environment and application requirements are unique for every industrial scale so performance must be tested and certified. Our calibration services and certificates document accuracy to ensure production quality and provide a quality system record of performance.
 - c. **Periodic Calibration Maintenance:** A Calibration Service Agreement provides on-going confidence in your weighing process and documentation of compliance with requirements. We offer a variety of service plans that are scheduled to meet your needs and designed to fit your budget.

© METTLER TOLEDO 2014

No part of this manual may be reproduced or transmitted in any form or by any means, electronic or mechanical, including photocopying and recording, for any purpose without the express written permission of METTLER TOLEDO.

U.S. Government Restricted Rights: This documentation is furnished with Restricted Rights.

Copyright 2014 METTLER TOLEDO. This documentation contains proprietary information of METTLER TOLEDO. It may not be copied in whole or in part without the express written consent of METTLER TOLEDO.

METTLER TOLEDO reserves the right to make refinements or changes to the product or manual without notice.

COPYRIGHT

METTLER TOLEDO® is a registered trademark of Mettler-Toledo, LLC. All other brand or product names are trademarks or registered trademarks of their respective companies.

METTLER TOLEDO RESERVES THE RIGHT TO MAKE REFINEMENTS OR CHANGES WITHOUT NOTICE.

FCC Notice

This device complies with Part 15 of the FCC Rules and the Radio Interference Requirements of the Canadian Department of Communications. Operation is subject to the following conditions: (1) this device may not cause harmful interference, and (2) this device must accept any interference received, including interference that may cause undesired operation.

This equipment has been tested and found to comply with the limits for a Class A digital device, pursuant to Part 15 of FCC Rules. These limits are designed to provide reasonable protection against harmful interference when the equipment is operated in a commercial environment. This equipment generates, uses, and can radiate radio frequency energy and, if not installed and used in accordance with the instruction manual, may cause harmful interference to radio communications. Operation of this equipment in a residential area is likely to cause harmful interference in which case the user will be required to correct the interference at his or her expense.

- Declaration of Conformity is located on the documentation CD.

RoHS Compliance Statement.





- The majority of our products fall within categories 8 and 9. Those categories currently do not fall within the scope of the Directive 2002/95/EG (RoHS) of January 27, 2003. If our products are intended for use in other products which themselves fall within the scope of the RoHS Directive, compliance requirements have to be separately negotiated contractually.
- Those products which fall within categories 1-7 and 10 will be in compliance with the EU RoHS Directive from no later than July 1, 2006.
- If it is not possible for technical reasons to replace any non-RoHS-compliant substances in any of the above products as required, we plan to inform our customers in a timely manner

Statement regarding harmful substances

We do not make direct use of harmful materials such as asbestos, radioactive substances or arsenic compounds. However, we purchase components from third party suppliers, which may contain some of these substances in very small quantities.

Warnings and Cautions

- READ this manual BEFORE operating or servicing this equipment and FOLLOW these instructions carefully.
- SAVE this manual for future reference.

	 WARNING
	ALWAYS REMOVE ALL POWER BEFORE SERVICING ANY EQUIPMENT. METTLER-TOLEDO RECOMMENDS THAT ONLY QUALIFIED TECHNICIANS OPEN THE UNIT UP FOR MAINTENANCE AND REPAIR. IF YOU MUST OPEN THE BC SCALE, READ THIS SECTION CAREFULLY TO AVOID DAMAGE TO THE INTERNAL COMPONENTS.
	 WARNING
	AC POWER SOURCES MUST HAVE PROPER SHORT CIRCUIT AND OVER CURRENT PROTECTION IN ACCORDANCE WITH LOCAL AND NATIONAL ELECTRICAL REGULATIONS. FAILURE TO PROVIDE THIS MAY RESULT IN BODILY INJURY AND/OR PROPERTY DAMAGE.
	NOTICE
	OBSERVE PRECAUTIONS FOR HANDLING ELECTROSTATIC SENSITIVE DEVICES.

Disposal of Electrical and Electronic Equipment

In conformance with the European Directive 2002/96/EC on Waste Electrical and Electronic Equipment (WEEE) this device may not be disposed of in domestic waste. This also applies to countries outside the EU, per their specific requirements.



Please dispose of this product in accordance with local regulations at the collecting point specified for electrical and electronic equipment.

If you have any questions, please contact the responsible authority or the distributor from which you purchased this device.

Should this device be passed on to other parties (for private or professional use), the content of this regulation must also be related.

Thank you for your contribution to environmental protection.

Contents

1	Introduction	1-1
1.1.	Standard Features	1-2
1.1.1.	BC15	1-3
1.1.2.	BC30	1-3
1.1.3.	BC60	1-3
1.1.4.	BC150	1-3
1.2.	Optional Accessories	1-3
1.2.1.	General	1-3
1.2.2.	0271 Graphical or 0270 Basic Display Options	1-4
1.3.	Specifications	1-4
1.3.1.	Physical Dimensions	1-4
1.4.	Power Requirements	1-5
1.5.	Environmental Requirements	1-6
1.6.	Standards Compliance.....	1-6
1.7.	RFI Susceptibility.....	1-7
2	Installation	2-1
2.1.	Unpacking	2-1
2.1.1.	Package Inspection	2-1
2.1.2.	Box Contents	2-2
2.1.2.1.	BC-15	2-2
2.1.2.2.	BC-60, 6L, 30, 3L	2-2
2.1.2.3.	BC-150	2-3
2.2.	Setup.....	2-3
2.2.1.	Scale Installation	2-3
2.2.1.1.	BC-150 Display Installation.....	2-3
2.2.1.2.	Scale Base Preparation, BC-150 Only.....	2-4
2.2.2.	Preparation, All Models	2-5
2.2.3.	PC Connection	2-6
2.2.3.1.	USB.....	2-6
2.2.3.2.	Serial.....	2-7
2.2.4.	Scale Configuration	2-8
2.3.	Installing Accessory Items	2-10
2.3.1.	Remote Displays	2-10
2.3.1.1.	Second Display, in Addition to Base-Mounted Display.....	2-11
2.3.1.2.	Wall-Mounted Display	2-11
2.3.1.3.	Dual Displays	2-11
2.3.2.	Ball and Roller Top Platters	2-12
2.3.3.	Conveyor Drop-In Kit for BC-150.....	2-13
2.3.3.1.	Conveyor Drop-In-Kit 64058112	2-13

3	Operation and Maintenance	3-1
3.1.	Power-Up Sequence	3-1
3.2.	Keypad and Display	3-2
3.2.1.	Display	3-2
3.3.	Keys and Navigation	3-3
3.3.1.	Navigation Keys	3-3
3.3.1.1.	Special Functions	3-3
3.3.2.	Softkeys	3-3
3.3.2.1.	Mode	3-4
3.3.3.	Page Layout in Weighing Mode	3-4
3.3.4.	Accessing and Navigating Setup Mode	3-5
3.3.4.1.	Entering Setup	3-5
3.3.4.2.	Navigation	3-6
3.4.	Operator Functions	3-8
3.4.1.	Parcel Weighing	3-8
3.4.2.	Zeroing the Scale	3-8
3.4.3.	Unit Switching	3-9
3.5.	Modes of Operation	3-9
3.5.1.	Selecting Modes	3-9
3.5.2.	Weight and Tare Mode	3-10
3.5.3.	Label Offset Mode	3-11
3.5.4.	Product Verification Mode	3-11
3.5.5.	Take-Away Mode: Differential Weighing	3-12
3.5.6.	Bulk Mail/Counting Mode	3-13
3.5.7.	Price Mode	3-14
3.6.	Cleaning and Regular Maintenance	3-14
3.6.1.	Overloads	3-14
3.6.2.	Display Check	3-15
3.6.3.	Cal Weight Check	3-15
4	Technical Manual	4-1
4.1.	Setup Parameters and Calibration	4-1
4.1.1.	Quick Setup to Carrier's Defaults	4-1
4.2.	Bypassing the Metrology Lock	4-2
4.3.	Scale Program Menus	4-4
4.4.	Configuration: Overview	4-6
4.4.1.	Entering Setup Mode	4-7
4.4.2.	Keyboard Shortcuts	4-7
4.4.3.	Exiting Setup Mode	4-8
4.4.4.	Remote Configuration	4-8
4.5.	Configuration: Info	4-8
4.5.1.	Model	4-9
4.5.2.	Cal Info	4-9

4.5.3.	Working Time	4-9
4.5.4.	BT	4-9
4.5.5.	Error Log	4-9
4.5.6.	HELP	4-9
4.6.	Defaults	4-10
4.7.	Operating Mode	4-11
4.7.1.	WtTare	4-11
4.7.2.	Hold	4-12
4.7.3.	LabOff	4-12
4.7.4.	TakeAW – Differential Weighign	4-13
4.7.5.	Price	4-13
4.7.6.	Count	4-13
4.7.7.	ProdVv	4-14
4.8.	Setup: Overview	4-14
4.9.	Setup: Display	4-15
4.9.1.	Language	4-15
4.9.2.	Filter	4-16
4.9.3.	Feedback.....	4-17
4.9.4.	Logo	4-17
4.9.5.	Custom Message	4-17
4.9.6.	Password	4-17
4.10.	Setup: Communications.....	4-19
4.10.1.	Serial	4-19
4.10.1.1.	Baud	4-20
4.10.1.2.	ASCII Data Bits.....	4-20
4.10.1.3.	Parity.....	4-20
4.10.1.4.	Stop Bit.....	4-21
4.10.1.5.	Protocol	4-21
4.10.2.	USB	4-21
4.10.3.	Ethernet	4-22
4.10.4.	Bluetooth.....	4-22
4.10.5.	SendWT	4-22
4.11.	Setup: Scale	4-23
4.11.1.	Metrology Lock.....	4-24
4.11.2.	Type Approval	4-24
4.11.3.	Set Default	4-25
4.11.4.	Capacity and Increment	4-25
4.11.4.1.	Primary Units.....	4-26
4.11.5.	Calibration.....	4-29
4.11.5.1.	Calibration Weight.....	4-29
4.11.5.2.	Calibration	4-30
4.11.5.3.	Use GEO	4-32
4.11.5.4.	Cal Prompt.....	4-34
4.11.6.	Zero	4-34
4.11.6.1.	Pushbutton Zero.....	4-35

4.11.6.2.	Zero Indicator	4-35
4.11.6.3.	Automatic Zero Maintenance	4-36
4.11.6.4.	Power-Up Zero	4-36
4.11.7.	Rounding	4-37
4.11.8.	Functions	4-37
4.11.9.	Boot-Up	4-38
4.11.9.1.	GeoCal	4-39
4.11.9.2.	Language and Units	4-39
4.11.9.3.	Manifest Software	4-39
4.11.9.4.	Exit	4-40
4.12.	Setup: Maintenance	4-40
4.12.1.	Overloads	4-40
4.12.2.	Display Test	4-41
4.12.3.	Calibration Check	4-41
4.13.	End	4-42
4.14.	Basic Display	4-43
4.15.	Metrological Sealing	4-44
5	Service and Repair	5-1
5.1.	Troubleshooting	5-1
5.1.1.	Error Codes	5-1
5.1.2.	Check Power Adapter	5-2
5.1.3.	Blank Display	5-3
5.1.4.	No Keypad Interaction	5-4
5.1.5.	Display Indicator Locked	5-4
5.1.6.	Serial Communication Test with PC	5-4
5.2.	Update Scale Software	5-8
5.3.	Main PCB Replacement	5-10
5.4.	Load Cell Replacement	5-13
5.5.	Base-Mounted Display Replacement	5-16
A	Serial (RS-232) Host Interface	A-1
A.1.	Communication Parameters	A-1
A.2.	Protocols	A-1
A.2.1.	ASCII Characters and Conversions	A-2
A.2.2.	Toledo Protocol Host Commands	A-4
A.3.	Scale Status Byte Information	A-5
A.4.	Scale Confidence Byte Format	A-5
A.5.	Calibrate Using Host Interface	A-6
B	USB Host Interface	B-1
B.1.	References	B-1
B.2.	Hardware	B-1

B.3.	Electrical Connection	B-1
B.4.	Power.....	B-2
B.5.	Protocol.....	B-2
C	USB Virtual Serial Driver.....	C-1
C.1.	Hardware.....	C-1
C.2.	Driver Installation	C-1
C.2.1.	Installation.....	C-2
D	Host Interface for Setup.....	D-1
D.1.	Software Application	D-1
D.2.	Driver Installation	D-1
E	Special Configuration.....	E-1
E.1.	Software Application	E-1
E.2.	Driver Installation	E-1
E.3.	Price Command.....	E-1
E.4.	Logo Command.....	E-1
E.5.	Custom Message Command	E-1
F	GEOCAL Codes	F-1

1 Introduction

This chapter covers

- Standard Features
- Optional Accessories
- Specifications
- Power Requirements
- Environmental Requirements
- Standards Compliance
- FRI Susceptibility

Thank you for purchasing a BC shipping scale from METTLER TOLEDO.

The BC scale, like all METTLER TOLEDO products, is designed for maximum durability and reliability in even the most demanding shipping applications. The BC is manufactured in one of METTLER TOLEDO's ISO 9000 certified facilities so you are assured to receive a high-quality product.

The BC scale is designed for robust use in parcel shipping, mail, and other light industrial environments. BC scale models have a wide temperature and humidity range and can be used on most unheated shipping docks.

The BC scale is a low profile, high precision scale designed to meet the needs of the legal-for-trade parcel/manifest markets. The BC scale is capable of communicating through Toledo, SICS, and the protocols of the major shipping carriers. The scale configuration can be customized, or easily programmed through default communication settings. For preconfigured models, set up is simple and easy with plug and play capability.

The BC scale family has 4 main models with maximum capacity at 15 kg (30 lb), 30 kg (70 lb), 60 kg (150 lb) and 150 kg (300lb). There are four postal versions with high resolution to process letters as well as parcels. Typical BC models and platter options are summarized in Table 1-1. Refer to the "Cap-inc" program block in Chapter 4 for the default capacity and increment settings.

The **letter and parcel** models provide the high resolutions required for shipping via postal and parcel carriers. The **parcel** models offer superb reliability for retail stores, mail rooms and shipping departments sending packages via parcel carriers or truck lines.

Table 1-1: BC Scale Versions

Model	Letter and Parcel				Parcel			
	BCA-15	BCA-30	BCD-3L	BCA-6L	BC-15	BC-30	BC-60	BCA 150
Capacity	30 lb 15 kg	70 lb 30 kg	70 lb. 32 kg	150 lb. (lb only)	30 lb 15 kg	70 lb 30 kg	150 lb 60 kg	150 / 300 lb. 60 / 150 kg
Readability	0-15lb x 0.1oz 15-30lb x 0.2oz	0-7lb x 0.1oz 7-70lb x 0.2oz	0-7lb x 0.05oz 7-70lb x 0.2oz	0-10lb x 0.1oz 0-70lb x 0.2oz 0-149lb x 0.5oz	0.01lb 0.005kg	0.05lb 0.02kg	0.05lb 0.02kg	0.05 / 0.1lb 0.02 / 0.05 kg
	0-3kg x 0.001kg 3-15kg x 0.005kg	0-15kg x 0.005kg 15-30kg x 0.01kg	0-3kg x 0.001kg 3-15kg x 0.005kg 15-32kg x 10g	0-5lb x 0.005lb 0-25lb x 0.05lb 0-150lb x 0.1lb				
Platter Construction	ABS Plastic	ABS Plastic Stainless Steel	ABS Plastic Stainless Steel	ABS Plastic Stainless Steel Ball Top	ABS Plastic	ABS Plastic Stainless Steel	ABS Plastic Stainless Steel Ball Top Roller Top	Stainless Steel Ball Top Roller Top
PC Connection	Standard: USB, RS-232, Virtual Serial, Keyboard Wedge Optional : Ethernet, Bluetooth				Standard: USB, RS-232, Virtual Serial, Keyboard Wedge Optional : Ethernet, Bluetooth			
Units	Lb., Lb-oz, Kg, g							

	Letter and Parcel				Parcel			
Model	BCA-15	BCA-30	BCD-3L	BCA-6L	BC-15	BC-30	BC-60	BCA 150
Approval	EC / OIML / NTEP / Metro. Canada / UL			NTEP / UL	EC / OIML / NTEP / Metro. Canada / UL			

The BC60 has 60 kg (150 lb) capacities. The BC150 (150 / 300 lb.) version is utilized for the applications that need a larger platter size.

BC6L, BC3L, and a version of the BC15 have multi-interval technology for high resolution, auto-ranging scales that are approved as weight classifiers for letters as well as parcels. It is like having multiple scales in one.

Additional information can be obtained from the MT website to help with installation and operation of the scale:

www.mt.com/IND-BCscale

In the unlikely event you experience difficulties operating your scale, please contact the local distributor or METTLER TOLEDO representative from whom you purchased the scale.

1.1. Standard Features

The following are standard features built into each BC shipping scale.

- High quality Mettler Toledo precision load cell that is capable of being programmed for Lb., lb-oz, Kg or grams.
- Unit switching between the selected primary and secondary units.
- Multi-interval capacities that provide better weight resolution at the lower range. Scale has auto range capability to automatically switch between intervals.
- Capacities and resolution can be customized. Legal for Trade units must be within approval requirements.
- GeoCal Setup compensates the sensitive factory calibration for local gravitational differences, eliminating the expense of an onsite calibration.
- Graphical display with soft key selections and easy to use navigation keypad. Intuitive interface that allows easy configuration of the scale.
- Adjustable display angle for better viewing
- Detachable display for remote mounting. Option for 2nd display in a graphical or seven segment option.
- Simple to communicate to a PC. Scale is capable of communicating via USB or RS232. For USB, the BC scale can be set up to use Microsoft POS HID scale protocol, virtual serial (serial communication over a USB cable), or Keyboard wedge functionality.
- Selectable communication protocols to match major carrier or manifest software's.
- USB Cable (10 ft.)
- RS-232 serial interface cable (10 ft)

- Universal Power supply with localized plug (Used with RS232, Ethernet, and BlueTooth communication, Scale is self-powered through USB connection)

The following features are specific to particular BC models.

1.1.1. BC15

- 30 lb / 15 Kg capacity
- Coated steel plate for base and sub-platter
- Base mounted display
- ABS Plastic platter

1.1.2. BC30

- 70 lb / 30 Kg capacity
- Die-cast aluminum base and sub-platter
- Base mounted display
- ABS Plastic or stainless steel platter

1.1.3. BC60

- Standard Capacity 150 lb / 60 Kg
- Die-cast aluminum base and sub-platter
- Base mounted display
- Stainless steel, ABS plastic, or ball top platter

1.1.4. BC150

- 150 lb / 60 Kg or 300 lb / 150 Kg capacity
- Painted steel base and sub-platter
- Display bracket with 14 ft cable where display can be base mounted or wall mounted
- Platter is typically packaged in a separate box.

1.2. Optional Accessories

1.2.1. General

- Ethernet Option and Bluetooth Option.
- Alibi Memory (Europe).
- Roller Top transfer platter (BC-60 and BC-150) is used for conveyor applications. It allows easy movement of package in bi-directional (right-left) motion.
- Ball Top transfer platter (BC-60 and BC-150) that allows easy rotation of package on the platter.
- Conveyor Rail mounting Kit.

- Platter overlay.
- Mounting Kit for In-Counter applications.

1.2.2. **0271 Graphical or 0270 Basic Display Options**

- Single wall mount display (Graphical or basic) with 14 ft. cable, replaces the base display.
- Single tower display (Graphical or basic) with 14 ft. cable for counter top mounting, replaces the base display.
- Dual wall mount displays (Graphical or basic) with 14 ft. cables, replaces the base display.
- Dual display tower (Both Graphical or both basic) with 10 ft. cable for counter top mounting, replaces the base display.
- 2nd display, wall- or tower-mounted (Graphical or basic) with 14 ft. cable. Used in conjunction with base display.
- 2nd display, base-mounted (Graphical or basic). Used in conjunction with first base display.
- Display cable extension kit, 14 ft. (basic only).
- RS232 extension cable, 10 ft with male / female adapters.

1.3. Specifications

The BC shipping scale conforms to and operates best within the specifications described in Figure 1-1, Table 1-2 and Table 1-3.

1.3.1. Physical Dimensions

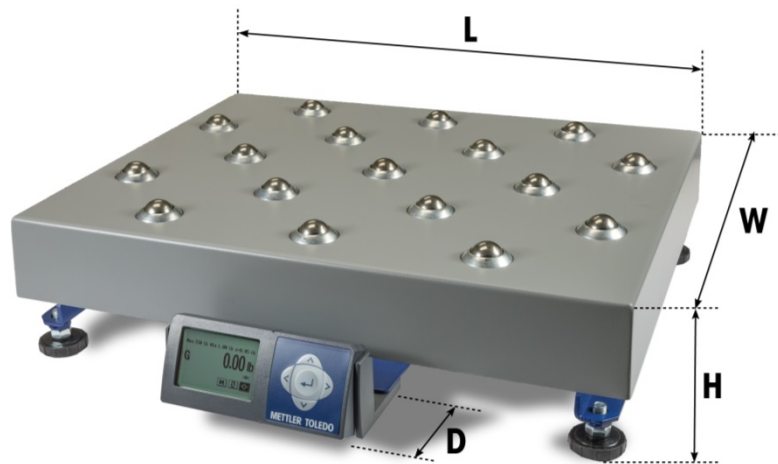

Figure 1-1: Key to Physical Dimensions

Table 1-2: Physical Dimensions of BC Scales, Pounds and Inches

		Weight and Dimensions									
		Scale					Shipping Box				
Model	Platter	Wt	L	W	H	D		Wt	L	W	H
PS15	Plastic	8	11.6	10.9	3.5	2		11	16	14	8
PS30	Plastic Stainless Steel	12	13.9	12.3	4	2		17	19	18	7.8
PS60	Plastic Stainless Steel	12	13.9	12.3	4	2		17	19	18	7.8
	Ball Top	19	13.9	12.3	5.2	2		23	19	18	7.8
	Roller Top	24	17	17.6	5.8	0		31	22	19	17
PS90	Stainless Steel	44	20.5	16.5	4.25	2.3		53	27	22	12
	Ball Top	54	19.8	15.8	4.8	2.6		65	27	22	15
	Roller Top	53	22.8	17.5	6.1	2		65	27	22	16

Table 1-3: Physical Dimensions of BC Scales, Kilograms and Millimeters

		Weight and Dimensions									
		Scale					Shipping Box				
Model	Platter	Wt	L	W	H	D		Wt	L	W	H
PS15	Plastic	3.6	295	277	88.9	51		5.0	406	356	203
PS30	Plastic Stainless Steel	5.5	353	312	102	51		7.7	483	457	198
PS60	Plastic Stainless Steel	5.5	353	312	102	51		7.7	483	457	198
	Ball Top	8.6	353	312	132	51		10.5	483	457	198
	Roller Top	10.9	432	447	147	0		14.1	559	483	432
PS90	Stainless Steel	20.0	521	419	108	58		24.1	686	559	305
	Ball Top	24.5	203	401	122	66		29.5	686	559	381
	Roller Top	24.1	579	445	155	51		28.6	686	559	406

1.4. Power Requirements

The BC operates over an input voltage of 5 VDC, at a current of 100 mA or less. The scale is powered through the USB port on the scale so the USB cable is always used for power.

- For USB operation, the scale communicates and is powered through the USB port of the PC. With the low power consumption, the BC scale is within the USB power requirements for connection to your PC without requesting additional power. Scale can also communicate and be powered through a USB hub.

An external 5 VDC power supply is required for power to the BC scale for standalone applications, RS232 applications, Ethernet applications or BlueTooth applications. For these applications, the scale will be powered by the universal power adapter located in the scale's shipping box. The wall mounted transformer is rated between 110-220V and 50-60 Hz. Connect the USB cable to the PC and then to the power supply. The power supply may have multiple plug adapters that can be clipped to the transformer based on the available country outlet.

1.5. Environmental Requirements

The BC scale is designed to operate in conditions of 10-90% relative humidity, non-condensing, and a temperature range of:

BC-15	0° to +40°C (+14° F to +104°F)
BC-3L	0° to +40°C (+14°F to +104°F)
BC-60	0° to +40°C (+14°F to +104°F)
BC-150	0° to +40°C (+14°F to +104°F)
BC-6L	+10° to +40°C (+14°F to +104°F)

The shipping and storage temperature range is -20° to +60°C (-4°F to +140°F) at 0 to 95% relative humidity, non-condensing.

The scale is designed for use in parcel shipping and other light industrial environments. This unit is not intended for wash down or hazardous area operation, nor for operation in environments of extreme heat, cold, or humidity (outside of the range listed above for each model).

1.6. Standards Compliance

The BC Family:

- Meets or exceeds USA NIST HB-44, EC and international OIML requirements for a 3000 division, Class III parcel scale.
- Meets UL and CE safety requirements.
- Meets RoHS and REACH material requirements.

1.7. RFI Susceptibility

The BC scale meets the requirements of the European Norm. 45501 for RFI susceptibility as listed below with a maximum of one display increment of change when calibrated for recommended builds.

Radio Interference Frequency	Field Strength
80 - 2000 MHz	10 volts/meter

2 Installation

This chapter covers

- Unpacking
- Setup
- Installing Accessory Items

This chapter gives detailed instructions and important information you will need to install the BC scale successfully. Please read this chapter thoroughly before you begin installation. This information is also covered in the **BC Quick Start Guide**.

2.1. Unpacking

2.1.1. Package Inspection

Please inspect the package as the carrier delivers it.

- If the shipping container is damaged, check for internal damage and file a freight claim with the carrier if necessary.
- If the container is undamaged, open the box, remove the scale, and place it on a solid, flat surface.

- The platter provided with the BC-150 is shipped in a separate box.

Please keep the packing material and shipping insert in case the scale needs to be returned to METTLER TOLEDO. The BC is a precision instrument and may be permanently damaged if not shipped in factory-approved packaging.

Open box and remove the packaging material from the top of the scale. Remove the platter (BC-15/30/3L/60/6L). Remove scale by grasping the bottom sides and lifting straight up. **Do not** lift the scale by grasping the sub-platter. Remove any protective shipping materials under the platter or sub-platter.

- If you choose to dispose of the package, please recycle the materials. The packaging is recyclable natural fiber with biodegradable adhesives. Refer to the list of recycling centers in the scale documentation

Locate a suitable environment for the scale.

- The proper environment enhances the operation and longevity of the scale.

The scale will need to be placed on a sturdy, level surface. Refer to Chapter 1 for environmental specifications. If communication to the PC will be serial RS232, Ethernet, or Bluetooth, the scale will need to be located near an AC outlet for power.

2.1.2. Box Contents

Check the contents of the box.

2.1.2.1. BC-15

Scale base and display

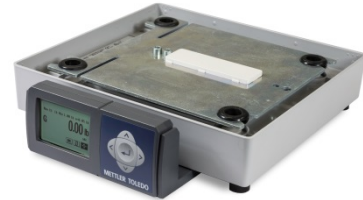

Platter



USB Cable – 10 ft. (for USB connection to PC)



Power Supply

(for Serial connection to PC)



RS-232 cable – 10 ft.



2.1.2.2. BC-60, 6L, 30, 3L

Differs from BC-15 only in the appearance of the base and platter

Scale base and display



Platter



2.1.2.3. BC-150

Scale base and display



Platter (in separate box)



Display with base/ wall-mount, adhesive pad, 14 ft. cable and clips



USB Cable – 10 ft. (for USB connection to PC)



Power Supply

(for Serial connection to PC)



RS-232 cable – 10 ft.



2.2. Setup

2.2.1. Scale Installation

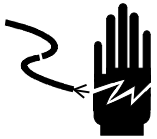
	! WARNING
	AC POWER SOURCES MUST HAVE PROPER SHORT CIRCUIT AND OVER CURRENT PROTECTION IN ACCORDANCE WITH LOCAL AND NATIONAL ELECTRICAL REGULATIONS. FAILURE TO PROVIDE THIS MAY RESULT IN BODILY INJURY AND/OR PROPERTY DAMAGE.

The BC shipping scale is fully assembled at the factory and ready for installation.

For the BC-60, BC-6L, BC-30, BC-3L, and BC-15, proceed to section 2.2.2.

2.2.1.1. BC-150 Display Installation

Mount the display and remove the shipping tabs as instructed below. The display can be mounted to the scale base, or wall-mounted.

2.2.1.1.1. Base Mounting

With black plastic clips in the insert position, attach display to the base by inserting the plastic clips at yellow arrows indicated below. Turn the plastic clips- 90 degrees to lock into position.

Replaced by screws?

2.2.1.1.2. Wall Mounting

Remove liner on one side of the adhesive pad and insert into the display bracket. Remove liner from the other side of the adhesive pad and position the display on the wall. Display should be located on the bottom portion of the bracket. Press bracket firmly against the wall until it is secured.

2.2.1.2. **Scale Base Preparation, BC-150 Only**

With the display mounted:

1. Connect the display cable to the display and scale at the two red arrows above. Note that the cable can be inserted through guide holes in the back of the display bracket. The scale connector panel will have four connectors. Insert cable at connector labeled "Display". The male cable connectors have a tab. Press cable into display connector and scale connector until the tab locks into position.
2. Wrap excess cable beneath scale. There are two grey clips on the bottom of the scale that the cable can be wrapped around.
3. Adjust the display angle according to the scale's mounting position. Hold the top and bottom of the display and gently rotate it up or down.

2.2.2. Preparation, All Models

1. Level the scale by turning the adjustable feet on the bottom of the unit. The scales are equipped with a level bubble. When the bubble is within the circle in the bubble indicator, the BC scale is level. The feet must be adjusted so the scale is stable and does not rock. After leveling, tighten the thumb wheel locking nut if equipped. The level bubble may be on the display bracket, under the platter or on a side bracket.

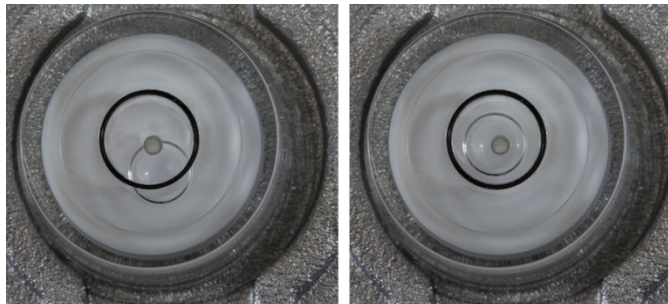

INCORRECT

CORRECT

Figure 2-1: Leveling the Scale

- Place the Platter on the scale. The platter is held in place by compression fit with the rubber grommets on the sub-platter, or spider.



Figure 2-2: Installing the Platter

- Confirm the method that will be used to connect the scale to the PC for communication. USB and RS232 configurations are possible. Choose one method only.



USB

RS-232

Figure 2-3: Connection Methods

- USB is preferred if the Shipping/Carrier manifest system supports and designates the scale for USB set up. Consult the Carrier's software documentation for details.
- USB must be used if the scale is to communicate with multiple shipping programs.

2.2.3. PC Connection

2.2.3.1. USB

USB is the preferred method of connection.

- Plug the small end of the USB cable (B connector) into the scale connector port marked **USB**.



Figure 2-4: USB Connections, Scale and PC

- The scale must be turned over to access the scale connector ports.

Plug the large end of USB cable (A connector) into the PC.

- A power supply is not required since the low power requirement of the PS scale is met by power from the computer's USB port.
- If the PC has difficulty powering the scale through the USB Port, connect scale to a powered USB hub, then connect the PC to the hub.

2.2.3.2.

Serial

Serial is the alternative method of connection. Note that the serial connection requires the use of the USB cable to supply power from an electrical socket via the transformer.



Figure 2-5: Serial Connections, Scale(left, top) and PC (bottom center); Power Supply (right)

1. Plug the small connector of the RS232 cable (B connector) into the scale connector port marked "RS232".

2. Plug the small end of the USB cable into the scale port marked **USB**.
 3. Locate the serial connector on your PC (typically labeled COM 1, COM A or IOIOI).
 4. Plug the large connector on the RS232 cable into the PC serial connector.
 5. Plug the large end of the USB cable (A connector) into the power supply and plug the Power Supply into an AC outlet.
- Note: BC-15, BC-150 Connectors are labeled in the reverse direction.
 - Note: If additional cable length is needed, a 10 ft RS232 extension cable - 0900-0322-000 (62010759) is available.
 - If the RS232 cable is plugged into the incorrect PC port, turn the computer off first, then change ports and reboot the computer.
 - If additional cable length is needed, see replacement parts for 10 ft. RS232 extension cable with appropriate connectors.
 - Use only the Mettler Toledo 5 VDC Power Supply to energize the scale.

2.2.4. Scale Configuration

The patented GEOCAL™ feature provides the best scale accuracy. This feature precisely compensates for gravitational differences between the factory location (where the scale was calibrated) and the scale's point of use location. Since the Earth's gravity varies based on latitude and altitude, the GeoCal feature allows the BC scale to maintain the sensitive factory calibration to ensure the most accurate weighting results.

- For Legal-For-Trade applications, contact your local Weights and Measure office for additional requirements and certification.
- Visit www.ncwm.net/state for listing of the US Weights and Measure offices by state.

2.2.4.1.1. GEO Calibration Values

Refer to **Appendix F** for a table of regions and corresponding GEO codes.

2.2.4.1.2. Graphical Display

1. Observe the display when the scale is first powered up:

If 0.00 displays, then GEOCAL is not activated, and no code is required. Proceed to step 7. For best accuracy, the scale should be calibrated on-site by a trained technician using certified weights.

If the initial boot screen (Figure 2-6) is displayed, the scale will prompt for the entry of a Geo code, and selections for language, unit selection and the type of manifest software the scale will communicate with.

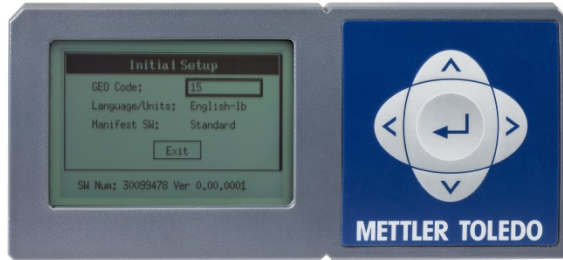

Figure 2-6: Initial Boot Screen, Graphical Display

2. Enter GEOCAL Set up code on Initial Boot Up screen.
 - Note: If the GEOCAL™ capabilities of your BC unit have been activated, the scale will only prompt for the “Geo in” code on the first power up.
3. Use the up ▲ and ▼ down arrows to scroll to and highlight the selection with the bolded box.
4. Use the left ◀ and right ▶ arrows to scroll through the selection’s parameters
5. Press Enter to accept the selection.
6. Geo Code - Press ◀ or ▶ to scroll through the code numbers. Refer to Appendix F for the correct code. Numbers will repeat. Press Enter to accept.
7. Language / Units - Use the up ▲ and down ▼ arrows to scroll to and highlight the Language parameter. Press ◀ or ▶ to scroll through the options: **English – Lb.**, **English – Kg**, **French**, **Spanish**, **German**, and **Chinese**. Options will repeat. Press Enter to accept.
8. Manifest SW - Use the up and down arrows to highlight the manifest parameter. Press ◀ or ▶ to scroll through the options: **FedEx ShipManager**, **UPS World ship**, **DHL EasyShip**, **Purolator E-Ship**. Options will repeat. Press Enter to accept.
 - If the correct GEOCAL code was not entered at first power up, refer to Chapter 4 to reset the feature for the next power up.
 - For states that have multiple listings, choose the location that is closest. The GeoCal code within a state is based on latitude and is segmented between north and south directions only. Locations near a boundary can chose either code.

2.2.4.1.3. Basic, 7-Segment Display

If “GEo in” is displayed, enter the two digit GeoCal Location Code for the area where the scale will be used. Refer to Appendix F for the correct code.



Figure 2-7: GEOCAL Screen, 7-Segment LCD Display

The sequence for selecting a GEOCAL™ code is as follows:

1. Press the ZERO key repeatedly to scroll through the Codes. If the correct code is missed, keep scrolling since numbers will repeat
2. Select the desired code by pressing the UNITS key once. DONE will be displayed.
3. Press the UNITS key a second time and the scale will reboot and display 0.00.

2.2.4.1.4. PC Configuration

Configure the Carrier or Shipping software on the PC to communicate with the scale. Open your carrier or shipping software and go to the Set Up screen. Select the proper scale model from the pull-down list. (Example: Toledo BC-60).

For additional assistance, contact the shipping software provider.

2.3. Installing Accessory Items

2.3.1. Remote Displays

METTLER TOLEDO offers several options for displays: they can be base-, wall- or tower-mounted.

- Power down the scale before plugging in a remote or base mounted display. If display is plugged in "Hot" and is displaying erratically, power down the scale for 10 seconds and reboot.
 - The base mounted display has the display mounted to the scale base.
 - Wall mounted displays allow the weight to be seen at eye level.
 - Tower mounted display is typically used for mounting on a counter top.

Remote displays are often used for better visibility. Most scales are ordered with a base-mounted display. Remote wall or tower displays are typically used where package size is large enough to obstruct the view of the scale's base display. In Legal-for-Trade applications, a customer-facing display is typically required in addition to the operator-facing display.

There are two display connectors (RJ45) on the scale, and it can support two displays. Each display will have its own cable.

There are two display types, the graphical display model 0271 and the basic display model 0270 (seven segment LCD). The display types can be mixed, except in dual tower displays (where a single tower supports two back-to-back displays).

- The 0271 model consists of a monochrome graphical display. The 0271 can show special messages and the added value applications. The 0271 display will recognize the scale and display the correct capacity and increment.
- The 0270 model is for basic weighing only and needs a printed lens to show the capacity and increment size. The display needs to be matched to the scale capacity and increment size. So changing the build requires a new Lens for the 0270 model.

2.3.1.1. Second Display, in Addition to Base-Mounted Display

A 2nd wall- or tower-mounted display can be added in parallel to the base display with the use of a 10 ft cable. Display kits are 0270-3X00-000 or the 0271-3100-000 (30125729). To install this option:

Figure 2-8: Second Display Installation

1. Disconnect power to the scale and locate the scale connectors on the bottom of scale.
 2. The base display should already be connected to one of the display connectors. Locate the other unused connector marked "Scale display", insert the jack of the 10 ft. cable, closest to the ferrite, into this RJ45 connector port.
 3. Mount remote display (Wall or Tower) in proper location with mounting screws.
 4. Connect the other end of the cable into the back side of the remote display.
 5. Power up the scale.
- Make sure any excess cable is properly secured and does not provide a trip hazard for personnel or customers

2.3.1.2. Wall-Mounted Display

If the base display is **not** desired, then a single wall mounted (0270-3X00-000), or tower mounted displays (0270-2X00-000) can be substituted for the scale base display. These remote displays include a 10 ft. cable.

1. Disconnect power to the scale and locate the scale connectors on the bottom of the scale.
2. For the connector marked "Scale display", disconnect base display cable by pressing in the latching tab on the jack while pulling the cable out. Remove the screws mounting the Base Display.
3. Mount remote display (Wall or Tower) in proper location with mounting screws. Connect the Display Cable into the one of the Scale Display Jack and the remote display.
4. Power up the scale.

2.3.1.3. Dual Displays

If two displays are needed and the base display is not desired, then use one of the following options:

- Dual wall mounted display
 - Two 0270-3X00-000 each with a 10 ft. cable or
 - Two 0271-3100-000 each with a 10 ft. cable,
- 2 sided Tower display
 - 0270-6X00-000 with one Y cable
 - 0271-6100-000 with two 10 ft. cable

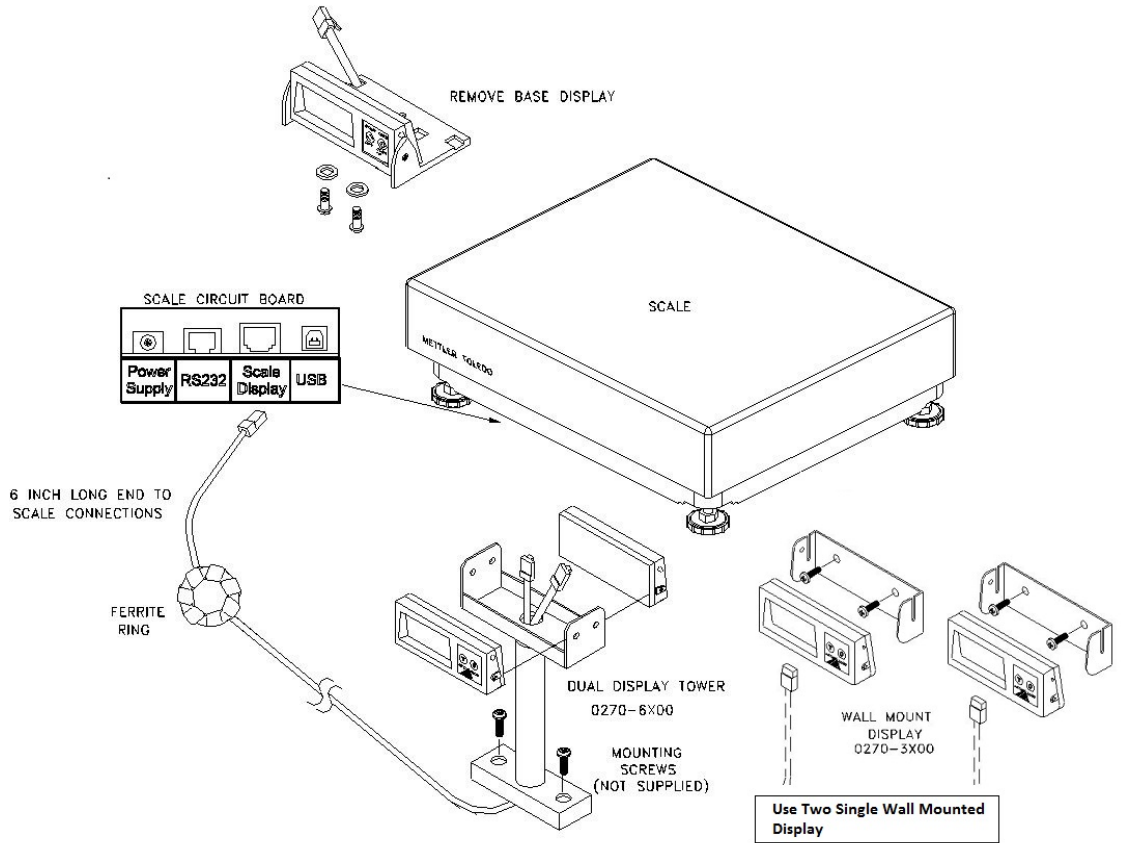

Figure 2-9: Dual Displays

1. Disconnect power to the scale and locate the scale connectors on the bottom of the scale.
2. For the connector marked "Scale display", disconnect base display cable by pressing in the latching tab on the jack while pulling the cable out. Remove the screws mounting the Base Display.
3. Connect the Display Cable/s into the Scale connector labeled Display Jack
4. Mount remote display (Dual Wall or Tower) in proper location with mounting screws. Connect the Display Cable into each display.
5. Power up the scale.

2.3.2. Ball and Roller Top Platters

A ball top or roller top transfer platter is available for the BC-60 and BC-150. To install the ball or roller transfer platter:

1. Remove the platter supplied with the BC-60. BC-150 can be ordered without a platter.
2. Place the ball or roller top transfer platter on the BC - scale.
3. Ensure that the ball or roller top transfer platter drops into place without mechanical interference.

- If the unit fails to capture zero, reboot the scale by cycling power (unplug the Wall transformer and/or USB cable). Reconnect the power source. If the scale still fails to capture zero, re-calibration will be required. The difference in dead load between platter types can be substantial and outside the power-up criteria of the scale.

2.3.3. Conveyor Drop-In Kit for BC-150

The Conveyor drop in kit includes two adjustable width rail brackets that allow a BC-150 scale to be integrated into a standard gravity conveyor, that measures between 22 and 32 inches wide (between the conveyor frame rails). The kit is designed for standard conveyors that use 1.9" diameter rollers on a frame that supports 1.5" spacing increments.

NOTICE

DO NOT ATTEMPT TO INSTALL THIS KIT IN A POWERED CONVEYOR.

2.3.3.1. Conveyor Drop-In-Kit 64058112

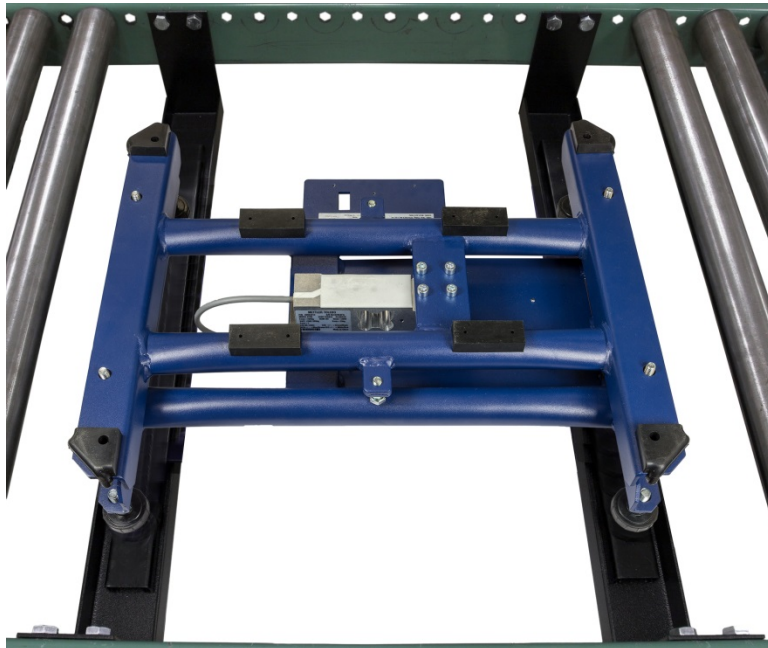

Figure 2-10: Conveyor Drop-In Kit Installed

Reference the detailed instructions (document 64058111) provided in the shipping box, or obtain a copy at www.mt.com/ind-BCscale.

- The BC-150 scale can be mounted lengthwise or transverse in the conveyor frame for the Ball Top Platter. The ball-top platter allows packages to be rotated easily when on the scale. This option is commonly used when packages have labels that must be scanned at the shipping station.
- The BC-150 scale should always be mounted lengthwise when used with the roller-top platter. The roller-top platter is commonly used when packages are significantly larger than the scale.

3 Operation and Maintenance

This chapter covers

- Power-Up Sequence
- Keypad and Display
- Keys and Navigation
- Operator Functions
- Modes of Operation
- Cleaning and Regular Maintenance

This chapter provides operating instructions for the BC scale during normal operation. Before weighing parcels, the BC Scale should be configured properly and power applied as instructed below. How the scale operates is based on the parameter settings selected in the setup program. Refer to Chapter 2 for installation instructions and Chapter 4 for advanced programming of the setup parameters.

3.1. Power-Up Sequence

- The scale is energized whenever power is applied to it (plugged in), and de-energized when power is removed (unplugged).
- A power adapter is not needed for USB connection to a PC since the power requirements are within standard USB specifications of 100ma.
- The PC can provide additional power up to 500 mA, required for scale options.
- In the unlikely event that the PC is not providing power through the USB port, a powered USB hub can be used.
- Special software versions may be used for specific applications.
- If a power switch is required, use a terminal strip with a power switch.

Power is applied by plugging the scale into a power source. Since the scale is a USB peripheral device with low power consumption, it does not have a typical on/off switch. The scale operates similar to a USB keyboard or PC mouse where a power switch is not needed. To power up the scale:

USB communication

Plug in USB cable to an energized PC. Power can also be supplied from a powered USB hub between the scale and PC.

Other communication (RS232, Ethernet,* Bluetooth*)

Plug in USB cable to the power adapter and then plug the power adapter into an AC outlet.

* The Ethernet and Bluetooth options are not currently available.

When using other communication types than USB, the power input to the scale is through the USB cable and a power adapter with USB connection (like many cellphones).

The BC goes through a power-up sequence each time power is applied. The scale performs a diagnostic test on its ROM and RAM, and then proceeds to the normal operating mode. The power-up sequence is as follows:

1. All pixels or segments of the display characters are activated. This verifies operation of all display segments.
2. The scale displays the software part number followed by the software revision status. Software number for the **standard** BC model is 30099478, version 00.00.01.
3. The scale then captures zero based on the Power Up zero setting, which can be $\pm 10\%$ or 20% of calibrated capacity, and is ready for normal operation.
4. To turn off the scale, unplug the power source to the scale:

USB	Unplug the USB cable (and power adapter if used).
Other (RS232, Ethernet, Bluetooth)	Unplug the power adapter from AC outlet.

3.2. Keypad and Display

The BC scale includes a monochrome graphical display and a navigational keypad with a central "Enter" key. The keypad is similar to a TV remote control and can scroll up, down, right, and left between soft selection keys on the display. An item is selected by scrolling to its position and pressing the center "Enter Key". The keypad is used for scale operation as well as configuration.

- A Basic 0270 LCD display can also be used for weight display only. The 0270 display is very limited in set up capability, and has a zero key and unit switching keypad.

Press the navigation keys by placing one finger behind the bottom-right corner of the display to support it while pressing the keys with the thumb (similar to texting on a cellphone).

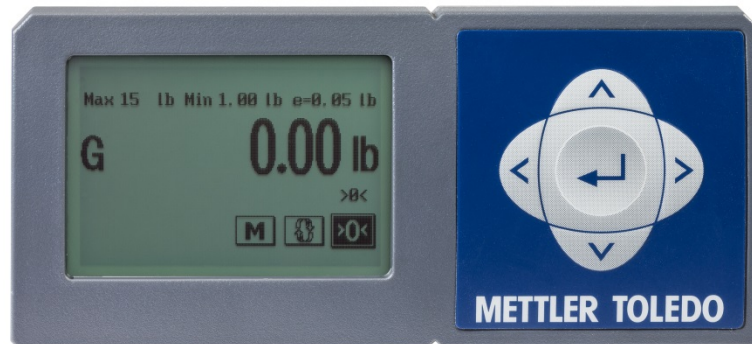

Figure 3-1: Graphical Display, Default Screen

The R1 / R2 / R3 icon will indicate the weight range on Multi-Range models. Range indication is not needed with Multi-Interval models that have auto-ranging capability.

3.2.1. Display

The BC scale graphical display has a monochrome screen with a resolution of 240 x 160 pixels. Each weight digit is 12 mm high standard, with option for 21mm high. The BC's status symbols

(Ranges, Gross/Net, center of zero, etc.) are smaller letters and appear below the weight data or to the left. Units (Lb., oz., Kg) are to the right of the data and are also in smaller letters.

The display area also indicates over-capacity and under-capacity conditions. Over- and under-capacity are indicated on the display as follows:

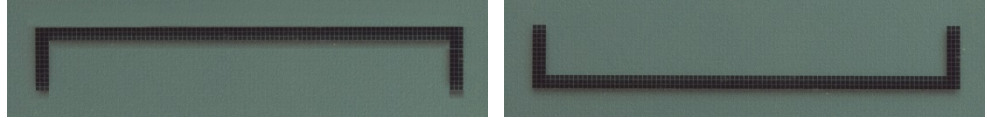

Figure 3-2: Over- and Under-Capacity Displays

3.3. Keys and Navigation

The BC keypad contains a navigation key for easy scrolling and selection of the softkeys, as well as entering of parameter options.

3.3.1. Navigation Keys

Four navigation keys (Figure 3-3) allow the cursor to be moved UP, DOWN, RIGHT, and LEFT, to select softkeys and parameters on the graphical display. The position of the cursor is indicated by the softkey box (outline) being shown in bold (e.g., Figure 3-5). The central ENTER key allows selection of the softkey.

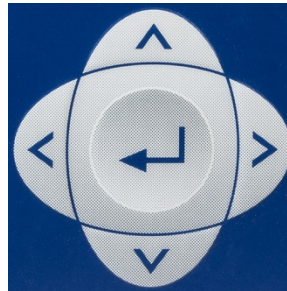

Figure 3-3: Keypad, Graphical Display

3.3.1.1. Special Functions







Press and hold the UP key for 5 seconds to enter **Setup** mode.

Press the DOWN Key to increase numeric weight characters to 20mm (only If TYPE APPROVAL is set to "No"). To exit this display mode press any key.

3.3.2. Softkeys

Table 3-1 lists the softkeys available in the scale, and describes each softkey's function.

Table 3-1: BC Scale Softkeys

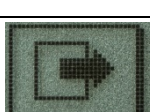
Position	Symbol	Function	Description
6		Zero	Zero the scale - nothing on the platter. If Pushbutton Zero is not set for 0%, this softkey will appear in all modes.
5		Switch Units	Toggle between primary and secondary weighing units. If Unit switching is enabled, this softkey will appear in all modes.
4		Mode	Open the Mode page to select the weighing process. If Basic Weigh is the only mode available, this softkey will not be shown. See list of modes below.
3		Tare	Tare a container on the scale for a Net weight instead of Gross weight.
2		APW	Calculate the average piece weight (APW) of a quantity of items. This softkey appears if Bulk Mail / Counting mode is enabled.
		Hold	Activate the Hold function for weighing large parcels that may block the view of the scale display. Function maintains weight reading on the display after parcel is removed. If enabled, this softkey will appear in Basic Weigh mode only.
1		SendWT	Manually send weight from scale for serial communication. If Send weight (SendWT) is configured for Send Key, this softkey will appear in all modes.

In normal operating mode, these keys function as follows.

3.3.2.1. Mode

Press the **Mode** key to access available modes of operation.

3.3.3. Page Layout in Weighing Mode

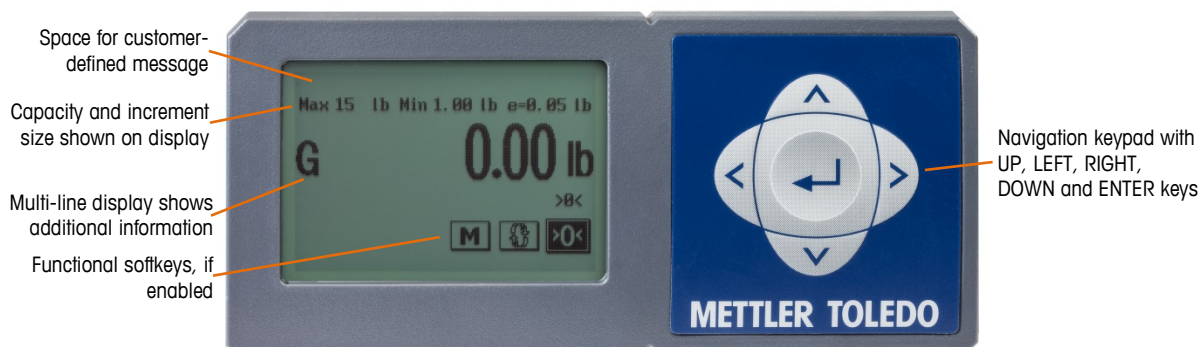

Figure 3-4: Weighing Mode Display

The screen may include one or more of the following status indicators:

- G Gross weight
- R1 Current weighing range, in multi-range configuration
- >0< Center of Zero

3.3.4. Accessing and Navigating Setup Mode

3.3.4.1. Entering Setup

To enter setup, press and hold the UP key for 5 seconds. The **Home** screen will display.

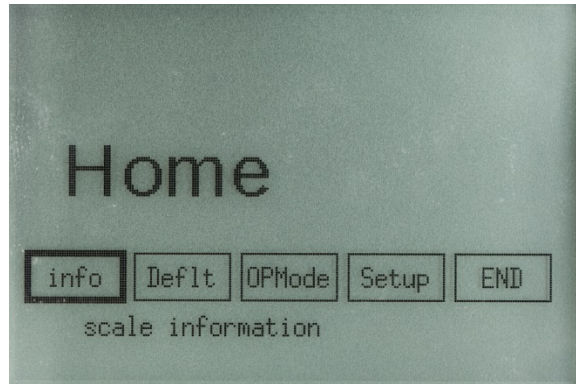

Figure 3-5: Home Screen

Use the RIGHT arrow to scroll to select **Setup**, then press ENTER. The first **Setup** screen will appear.

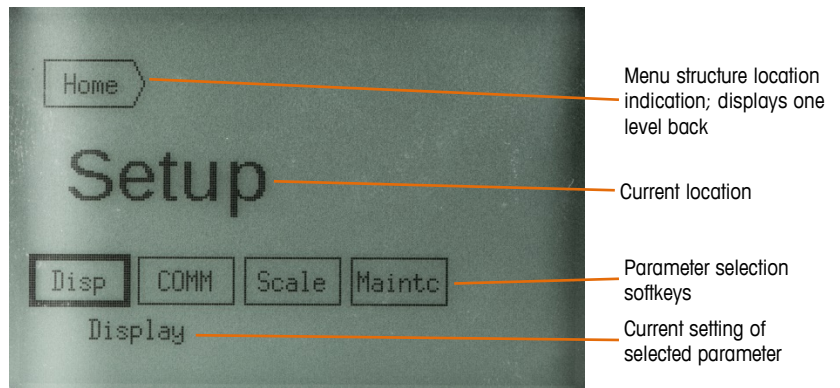

Figure 3-6: Initial Setup Mode Display

A typical setup screen includes the elements shown in Figure 3-7.

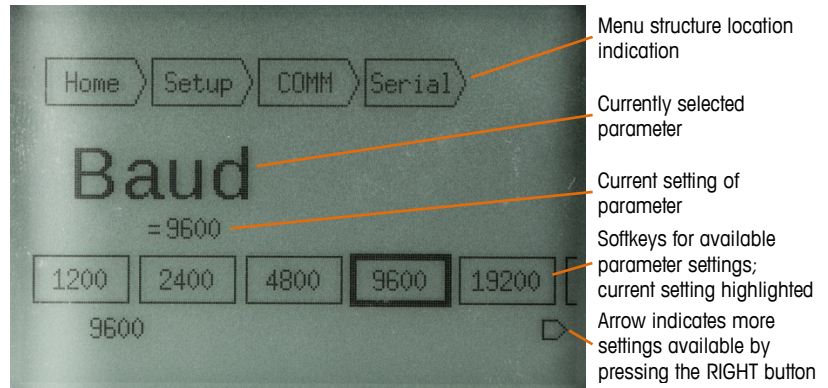

Figure 3-7: Typical Setup Screen

3.3.4.2. Navigation

A small arrow at the bottom right of the screen (as in Figure 3-7) indicates that more settings are available on the next page; press the RIGHT arrow to scroll to it.

To select the menu structure soffkeys at the top of the screen, press the UP key; then press LEFT or RIGHT to select a screen, and ENTER to access that screen.

To reduce keystrokes, the selection wraps around. For example, pressing RIGHT five times in Figure 3-8 will return to highlight **Baud**.

If TYPE APPROVAL is set to **No**, press the DOWN arrow when in weighing mode to show the large 21mm typeface.

3.3.4.2.1. Exiting Current Screen

When a setting soffkey is selected, and its setting is current (for example, in Figure 3-7 **9600** is highlighted, and **9600** is the current setting), pressing ENTER returns the display to the next level up – this case, the **Serial** setup screen (Figure 3-8).

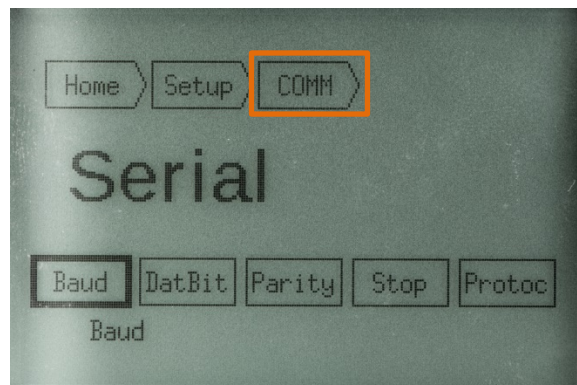

Figure 3-8: Serial Setup Screen

3.3.4.2.2. Exiting Setup

At any point when in setup, press and hold ENTER for 5 seconds to jump immediately to the END (exit) screen (Figure 3-9).

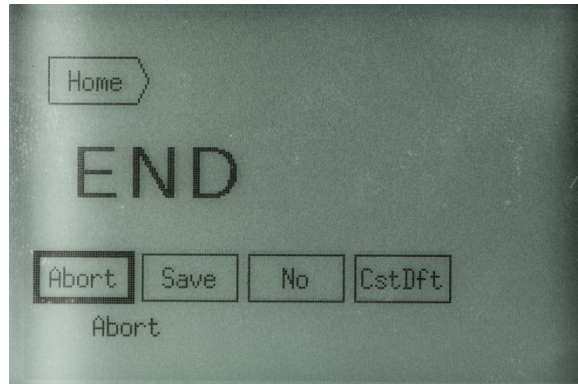

Figure 3-9: END Screen

- Saving changes will cause the scale to restart in order to implement the changes.

Options available on this screen are:

Abort After a warning notice displays, returns to weighing mode without saving any changes made to the scale configuration while in setup.

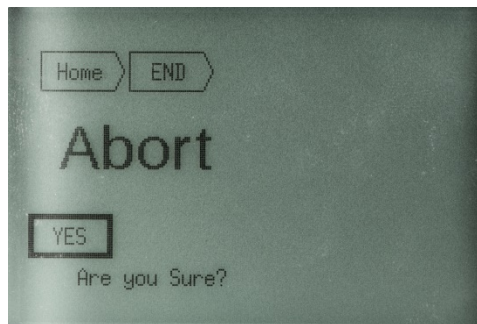

Figure 3-10: Abort Confirmation Screen

Save After displaying a notice screen, saves changes made in setup, restarts the scale, and returns to weighing mode.

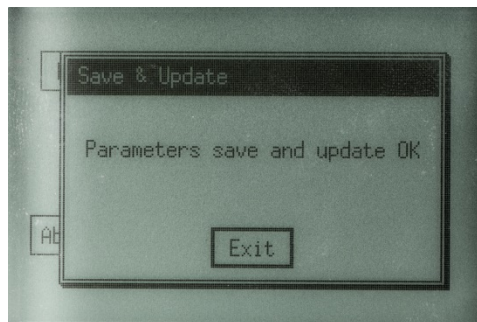

Figure 3-11: Save and Update Confirmation Screen

- No** Returns view to the **Home** screen. Pending changes are neither saved nor abandoned.
- CstDff** Saves the current configuration as the custom default, and returns to the **Home** screen.

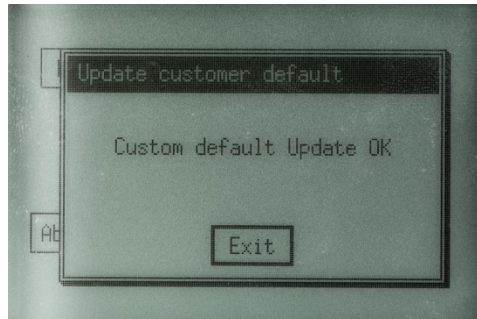

Figure 3-12: Custom Default Update Confirmation Screen

3.4. Operator Functions

The BC scales are easy to operate, and support one primary function: parcel weighing. With the two-key display, the operator has functions for:

- Unit switching
- Zeroing the scale

3.4.1. Parcel Weighing

To weigh a package:

1. If the display shows a weight when there is nothing on the platter, press ZERO to capture zero. The display will read **0.00** and, if enabled, a center of zero icon (>0<) will appear on right side of screen.
2. Place the parcel to be weighed on the platter. The display reads the parcel weight with corresponding units of weight (lb. or kg) in smaller font.
3. Record the parcel weight as needed, then remove the parcel from the platter.
 - You may wish to recapture zero periodically when the scale is in continuous use. It is not necessary to press ZERO before each transaction.

3.4.2. Zeroing the Scale

- Most scales are set up to re-zero if weight is within 2% of the scale capacity. If the zero change exceeds the 2% limit, the scale will not capture zero. In this case, cycle power or recalibrate.

Remove all weight and debris from the scale platter and press ZERO to capture the zero weight. The BC display will indicate a zero reading 0.00 and a center of zero icon (>0<) on the right side of the screen. The scale will re-zero provided the weight is within the designated percentage of scale capacity as programmed in setup (XREF).

If the scale does not capture zero with the above procedure:

1. Unplug the scale, remove all weight from the platter, make sure nothing is touching the platter, and reconnect the power.
2. If cycling power does not work, recalibrate the scale as described in Chapter 4.

3.4.3. Unit Switching

- Some selections made in setup, such as Multi-Interval capacities, may inhibit unit switching inhibited. In this case, the only option available will be **Disabled**.

The BC scale allows the displayed scale weight to be viewed in primary and secondary units. Unit switching must be enabled in setup mode (refer to section 4.11.4 in Chapter 4) to convert and display in secondary units. The primary units are also designated in setup (refer to section 4.11.4 in Chapter 4)

To switch units:

1. With scale weight displayed, press the UNITS key. The BC scale automatically converts the displayed primary weight to the secondary weight unit.
2. Press UNITS again to switch the scale back to the primary units. The weight shown on the display will be the primary units as indicated by the cursor.

3.5. Modes of Operation

3.5.1. Selecting Modes

The BC scales have seven operating modes. Press the MODE softkey to access other modes of operation. Depending on the scale's configuration, a screen like the one shown in Figure 3-13 will appear.



Figure 3-13: Mode Selection Screen

Selections are:

Selections are:

Basic Weighing

Gross weight only

Weight and Tare	Tare a container for Net weight instead of Gross weight.
Label Offset	Gross plus an offset weight to compensate for labels added after weighing process.
Take Away Mode (Differential weighing)	Gives the decremented differential weight to weigh letters pulled out of a container.
Product Verification	Gives incremental differential weight for verification of an item placed into the parcel at a packing station.
Bulk Mail / Counting	Weighs sample quantity to give Average Piece weight.
Show Price	The scale will display the price calculated and communicated from the local PC for the item weighed.

When the **Mode** page opens, the current mode's softkey is highlighted in bold, and its description appears at the bottom left of the screen. Use the navigation keys to scroll to softkey for the desired mode, then press ENTER to select it. The mode description will be updated with the newly selected mode. Press ENTER again to exit the Mode page.

If a mode is disabled, the rectangle box around its name will consist of small dashed lines instead of solid lines. A disabled mode cannot be selected.

Modes are enabled in two places:

- **Home > Setup > Scale > Func**, which is protected by the Metrology lock.
- **Home > OPMODE**, where function parameters are set. This area can be password protected by a manager.

Basic Weighing cannot be disabled. If Basic Weighing is the only mode available, the Mode softkey will not be shown.

3.5.2. Weight and Tare Mode

- Weight and Tare can be set for either **Auto Clear** or **Keypad Clear** in setup at **Home > OPMODE > WT-Tare > Enable**.

The **Weight and Tare** mode allows the container weight to be subtracted from the gross weight to provide the Net weight of the contents. Enable the Mode as described in section 3.5.1, above.

1. If the display shows a weight with nothing on the platter. Press ZERO to capture zero. The display will read **0.00** and, if enabled, a center of zero icon (>0<) will appear at lower right on the screen.
2. Place the container to be used on the platter. Scroll to the **Tare** softkey and press ENTER to tare the container. The display will read **0.00** with the container still on the scale, and an **N** for NET weight will appear. Add material to the container. The display reads the NET weight of the material with corresponding units of weight (lb. or kg) in smaller font.
3. Record the NET weight as needed, then remove the container from the platter.
4. If **Auto-Clear Tare** is selected, the tare will be cleared once the scale sees a zero gross weight. If **Keypad Tare** is selected, the tare is cleared only when the TARE softkey is pressed with nothing

on the scale platter. Keypad tare is used when the same container will be used for multiple weighments.

3.5.3. Label Offset Mode

- Label Offset can be set for an Auto Clear or Keypad Clear in **Home > OPMODE > LabOff > Enable**.

Parcels are always weighed and dimensioned by the carriers, and if the addition of the packing list causes the parcel to weigh into the next pricing tier, the carriers will implement back charges. With Carrier pricing tiered at every whole pound or ½ kg, there is plenty of opportunity for back-charges to occur on an average shipping day. For “Prepay and Add” parcels, the back charges cannot be recovered.

Label Offset mode is designed to minimize these back-charges from Carriers in a non-legal for trade application. It is similar to a Tare but it adds an offset instead of subtracting one. This mode allows compensation for items added to the parcel *after* the final weight was taken for weighing and pricing of the shipping service. Typical items are labels and packing lists which can equate to several scale increments. This is important in “Pre-pay and Add” transactions where several US dollars could be lost per back-charge.

In this mode, the displayed weight is the gross weight plus the offset weight tared into the scale. When this mode is in use, the display will show **G+** and the secondary line will show **OFFSET = 0.45 lb** (where the document weight is 0.45 lb). The document weight should be a representative sample to cover the majority of weighments. Enable the **LabOff Mode** as described in section 3.5.1, above.

1. If the display shows a weight with nothing on the platter. Press ZERO to capture zero. The display will read **0.00** and, if enabled, a center of zero icon (>0<) will appear on right side of screen.
2. Place the documents to be used on the platter. Scroll to the **Tare** softkey and press ENTER to input the document weight. The display will read twice the document weight with the document still on the scale. The **G+** will be displayed. Remove the document from the scale.
3. Add a parcel to the scale. The display will show the gross weight of the parcel plus the document offset. The corresponding unit of weight (lb. or kg) is shown in smaller typeface.
4. Record the G+ weight as needed, then remove the parcel from the platter.
5. If **Auto-Clear** is selected, the offset will be cleared once the scale sees a zero gross weight. If **Keypad Clear** is selected, the offset is cleared only when the TARE softkey is pressed with nothing on the scale platter. **Keypad Clear** is used when the same representative offset will be used for multiple weighments.

3.5.4. Product Verification Mode

Product Verification mode is designed for warehouse packing stations to verify the weight of each item placed added to the box during packaging. Weight verification eliminates mistakes. This mode will communicate the gross weight and the positive change in weight from the last stable weight. Gross weight is indicated by the “G” on the display, and is in the large typeface. The verification weight is shown below the Gross weight in smaller typeface.

During the packing of the box, the incremental weight can be communicated to a connected PC and merged with the last bar code scan, to confirm that the correct item was placed in the box. When the pick and pack order is complete, final packaging can be added, the box sealed, and final gross weight communicated for shipping services. Enable the **ProdVv** mode as described in section 3.5.1, above.

- If the display shows a weight with nothing on the platter, press ZERO to capture zero. The display will read **0.00** and, if enabled, a center of zero icon (>0<) will appear on right side of screen.
 - If an item is removed from the box it will show a negative incremental weight.
1. Place the packing box on the scale; note that the gross weight and incremental weight are the same. Scan the first item to be packed, and add the first item to the box. In large font, the display will show the Gross weight of the box and first item. The incremental weight will show only the first item.
 2. Record the + incremental weight as needed.
 3. Scan a second item and add it to the box. In large font, the display will show the Gross weight of the box, first item and second item. The incremental weight will show only the second item.
 4. Record the + incremental weight as needed.
 5. After weighing all items and sealing the box, record the gross weight for shipping.
 6. Remove the parcel from the scale. Scale will zero the Gross weight and incremental weight

3.5.5. **Take-Away Mode: Differential Weighing**

Differential Weighing mode is similar to **Product Verification** mode, but items are removed instead of added. Differential weighing is designed to accommodate a container of letters, where the whole container can be placed on the scale, and weights of individual letters are communicated as each is removed from the container. The container can be tared if necessary.

This mode communicates the gross weight (or Net weight, if a tare was taken) and the negative change in weight from the last stable measurement. Gross/Net weight is indicated by the **G/N** on the display, and is in the large font. The differential weight is shown below the Gross/Net weight in smaller font. Enable the **TakeAW** mode as described in section 3.5.1, above.

- If the display shows a weight with nothing on the platter. Press ZERO to capture zero. The display will read **0.00** and, if enabled, a center of zero icon (>0<) will appear on right side of screen.
 - If an item is removed from the box, a negative incremental weight will display.
1. Decide if a container is to be used or not:
 - a. If yes, place the container on the platter. Scroll to the Tare softkey and press ENTER to tare the container. The display will read **0.00** with the container still on the scale, and display an **N** for NET weight. Add letters to the container. The display reads the NET weight of the material with corresponding units of weight (lb. or kg). The tare value is still shown in the line below the Net weight on an increasing weight. It will show the decremented weight once a letter is removed.

- b. If no, place the letters on the platter. The display reads the Gross weight of the material with corresponding units of weight (lb. or kg).
2. Remove a letter and note the decremented weight in smaller font below the Gross/Net weight.
3. Record the decremented weight as needed.
4. Remove another letter and record the decremented weight as needed.
5. Remove additional letters until the Net value or Gross value is zero.
6. If Net is zero, remove the container, and tare the scale (scroll to the Tare softkey and press ENTER) with nothing on the platter.

3.5.6. Bulk Mail/Counting Mode

- Mettler Toledo offers a wide variety of counting scales. For higher accuracy or functionality, consult your local representative.
- For best results, zero the scale first to clear the tare before calculating a new APW.
- Bulk Mail/Count can be set at **Home > OPMODE > COUNT > Enable**. Once **Enable** is pressed, options for the APW quantity are shown.

The BC scales have a simple counting mode designed for bulk mailers and warehouse packing stations to determine non-critical quantities. Accuracy of the counting mode is based on the accuracy of the load cell. **Bulk Mail/Counting** mode allows for a sample of identical parts or letters to be weighed, and the Average Piece Weight (APW) recorded, to four decimal places. As more identical parts are added to the scale, the scale will calculate the estimated quantity by dividing the Net weight by the APW.

Enable the **Bulk Mail/Counting** mode as described in section 3.5.1, above.

1. If the display shows a weight with nothing on the platter. Press ZERO to capture zero. The display will read **0.00** and, if enabled, a center of zero icon (>0<) will appear on right side of screen.
2. Decide if a container is to be used or not:
 - a. If yes, place the container on the platter. Scroll to the Tare softkey and press ENTER to tare the container. The display will read 0.00 with the container still on the scale. The left side of the display indicates an N for NET weight. The units of weight (lb. or kg) are indicated on the right side. The tare value is still shown in the line below the Net weight.
 - b. If no, go to step 3. The display reads the Gross weight of the material with corresponding units of weight (lb. or kg).
3. Scroll to the **APW** softkey. Once the softkey is highlighted, the number of sample pieces to be added (i.e. 10) to the scale will display at the bottom of the screen. Place this quantity of items or letters on the scale. You will see the weight increase. Now, with the APW softkey still selected, press ENTER. The sample count (i.e. 10) will be shown on the display as well as the Average Piece Weight.
4. Add additional items or letters to the scale and the new count or quantity will automatically be displayed.
5. Record the count and APW weight as needed.

6. Remove the items from the scale. The APW will still be active. Add additional identical items for a new count with the **same** APW.
7. To calculate a **new** APW, remove all items from the platter. Put the new sample quantity on the scale and press ENTER to recalculate the APW.
8. Scroll to the ZERO softkey and press ENTER. The count will return to zero. Scroll to Tare or APW and enter a new COUNT sequence.

3.5.7. Price Mode

The Price mode is designed for retail counters and legal-for-trade applications. When this mode is enabled, a connected local PC will provide the scale the calculated total price of the current weighment. The weight and price will appear on the operator display, and on the remote customer display. No operator action is needed except to enable the Price Mode as described in section 3.5.1, above.

To disable the Price mode, scroll to the MODE Softkey and enable a different mode.

3.6. Cleaning and Regular Maintenance

The BC scale is basically maintenance free.

Depending on environmental conditions, it may be necessary to wipe the keypad and platter with a clean, soft cloth that has been dampened with a mild cleaner. Do not use any type of industrial solvent such as toluene or isopropanol (IPA). These may damage the display finish. Do not spray cleaner directly onto the display LCD. Make sure no overspray hits the cable connectors or circuit board.

The set up menu includes a **Maintenance** page (Figure 3-14) to assist with the longevity and accuracy of the scale. The maintenance setup screens are also described in section 4.12 of Chapter 4.

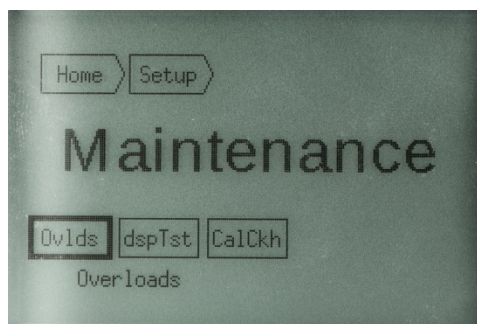

Figure 3-14: Maintenance – Selection Screen

3.6.1. Overloads

After selecting this softkey, a pop up window (Figure 3-15) will display the number of overloads the scale has experienced from heavy parcels or abuse. An overload may be registered due to the impact of a weight dropped onto the scale. The second line shows the cumulative time for which the scale was subject to an overload condition.

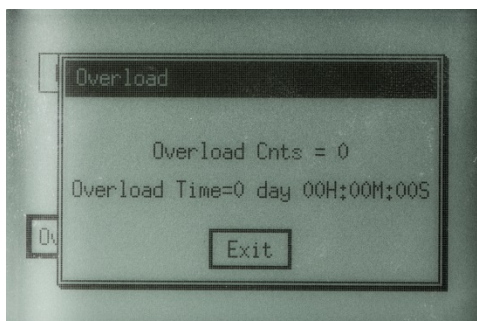

Figure 3-15: Maintenance – Overloads Display

3.6.2. Display Check

When this check is selected, the scale will cycle through a sequence of display views (Figure 3-16) to power each pixel. This is a check for any bad locations on the LCD display area.

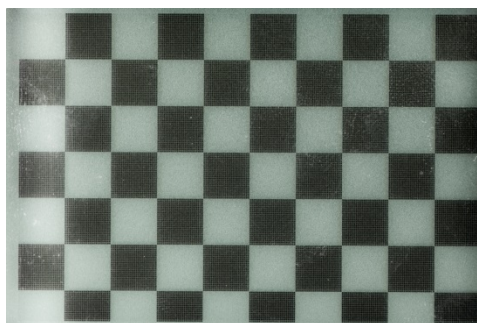

Figure 3-16: Maintenance – Display Check

3.6.3. Cal Weight Check

This test provides an expanded weight (x10) reading on a calibrated test weight to check the scale's accuracy before rounding.

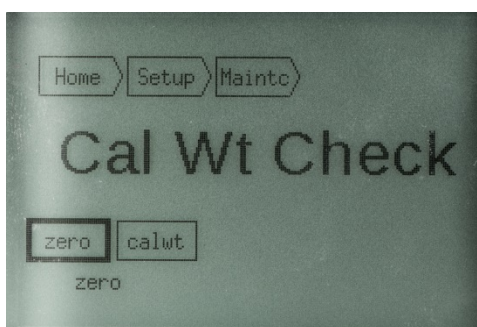

Figure 3-17: Maintenance – Cal Weight Check

First, press the zero softkey with nothing on the platter. A pop up window will appear stating **ZERO OK**. Select EXIT and press ENTER to proceed.

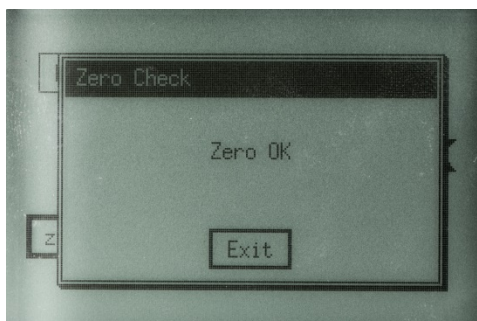

Figure 3-18: Zero Check

Next, place a test weight on the scale and scroll to the **CalWt** softkey. Press ENTER and a pop up window will show the expanded weight.

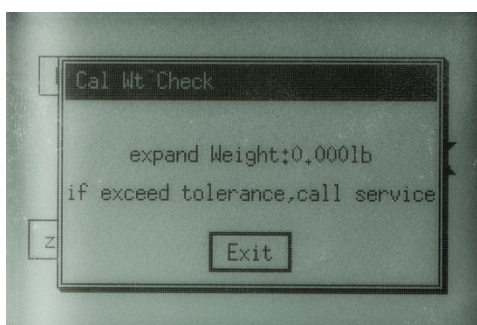

Figure 3-19: Cal Weight Check Pop-Up

The test weight must be within the scale capacity range.

The weight shown is the weight before rounding (X 10 resolution). If weight is outside tolerances, recalibrate the scale.

4 Technical Manual

4.1. Setup Parameters and Calibration

This chapter covers

- Setup Parameters and Calibration
- Bypassing the Metrology Lock
- Scale Program Menus
- Configuration: Overview
- Configuration Info:
 - Defaults
 - Operating Mode
 - Setup: Overview
 - Setup: Display
 - Setup: Communications
 - Setup: Scale
 - Setup: Maintenance
- End
 - Basic Display
 - Metrological Sealing

This chapter discusses basic information and specific instructions for configuring each program block of the BC scale, setting the operating parameters, and calibrating the BC scale.

The scale's interface program for the graphical display is shown in the menu trees in section 4.3. 62 functions or programming steps are available, with three levels of access:

- Normal set up parameters that can be accessed by any operator.
- Password-protected parameters for Manager Access only.
- Full access to all set up parameters after pressing the calibration button (Cal Button) under the green cap on the scale. Removing the green cap will require removal of the metrology seal if the scale is used in a Legal-For-Trade application.

The Metrology lock affects items in the **Scale** program block. Password protection affects parameters in the **Default**, **Operation Mode**, and **Setup** areas accessed from the **Home** screen.

4.1.1. Quick Setup to Carrier's Defaults

For a quick setup process that does not include calibration parameters, the BC scale menu has a specific default setting for each of the major Shipping Carriers (FedEx, UPS, DHL NA, Purolator, etc). Go directly to the **Default (Deflt)** soft key in the **Home** screen and select the default for the carrier. The scale will automatically input the other parameters (Baud, Parity, etc.); however, they are not yet saved at this point. Scroll to select **End** and press ENTER. From the **End** screen, select **Save**. Please use one of the default settings if you do not wish to customize the parameter settings and you are not calibrating the scale with test weights.

4.2. Bypassing the Metrology Lock

- Accessing the Cal button requires breaking the Weights and Measures seal.

When the Metrology Lock is enabled and an attempt is made to access the setup menus, the scale will request that the SW2 calibration (Cal) button be pressed. Pressing this button will momentarily by-pass the Metrology lock.

To access the scale setup menus, press the UP arrow on the keypad for five seconds. On the **Home** screen, use the RIGHT arrow to scroll to **Setup**.

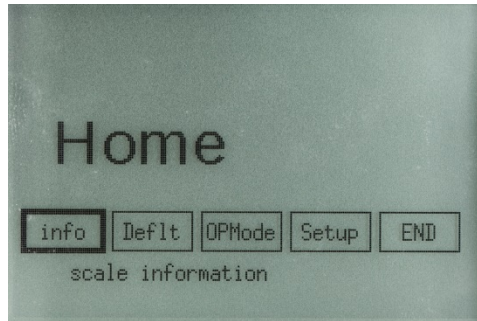

Figure 4-1: Home Screen

With **Setup** selected, press ENTER; a popup message will display requesting that the Cal button be pressed.

The SW2 Cal button is located under the green cap which is under the platter on the right center side of the scale (BC-60U / BC-30U), as viewed from display side.

First, remove the platter, then unscrew the green cap:

- | | |
|-------------------------------|---|
| BC15 | Turn scale over and remove the screw securing the plastic cover. Remove the slotted screw, lift the front edge of PCB Cover and pull it free from the rear base tabs. Press the SW2 Cal button. |
| BC30, BC3L, BC6L, BC60 | Remove the Platter. The green plug is located to the right of center on the scale housing. Break the Metrology seal if installed and unscrew the green cap. Use a stylus, pencil, or finger to push down on the SW2 switch and release. |
| BC150 | Remove the platter and remove Metrology screw or seal on the scale. Use a stylus or pencil to push down on the SW2 switch and release. |



Figure 4-2: Access to Cal Button, BC30, BC3L, BC60, BC6L

The Scale setup menu will appear.

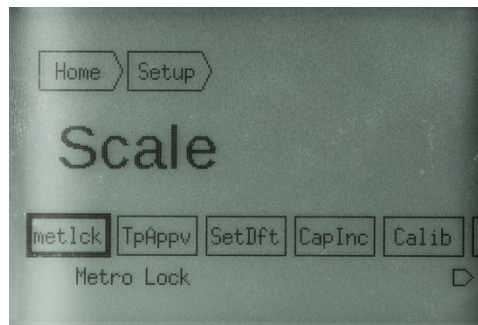

Figure 4-3: Scale Setup Menu

When leaving the **Scale** setup menus, the Cal button must be pressed again.

In non-Legal-for-Trade modes, the Cal button can be disabled by pressing the **metlck** softkey on the **Scale** menu, then pressing ENTER.

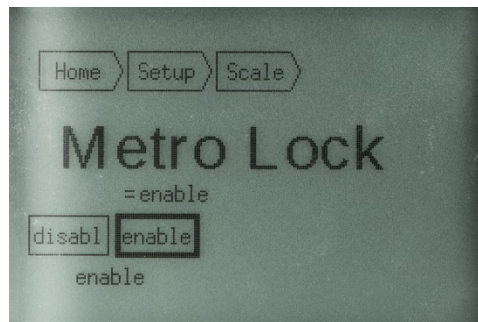

Figure 4-4: Metrology Lock Screen

The Metrology Lock can be **enabled** or **disabled**. Scroll to desired option and press ENTER to accept. To implement this change, **Save** the parameters from the **End** screen.

- Saving changed parameters will cause the scale to restart.

4.3. Scale Program Menus

The **Scale** menu screens are accessed by pressing the UP arrow for five seconds. Figure 4-5, Figure 4-6 and Figure 4-7 show all the branches of the menu structure. In these figures, blue shading indicates displays of information, while green shading highlights lists of parameter options available for selection.

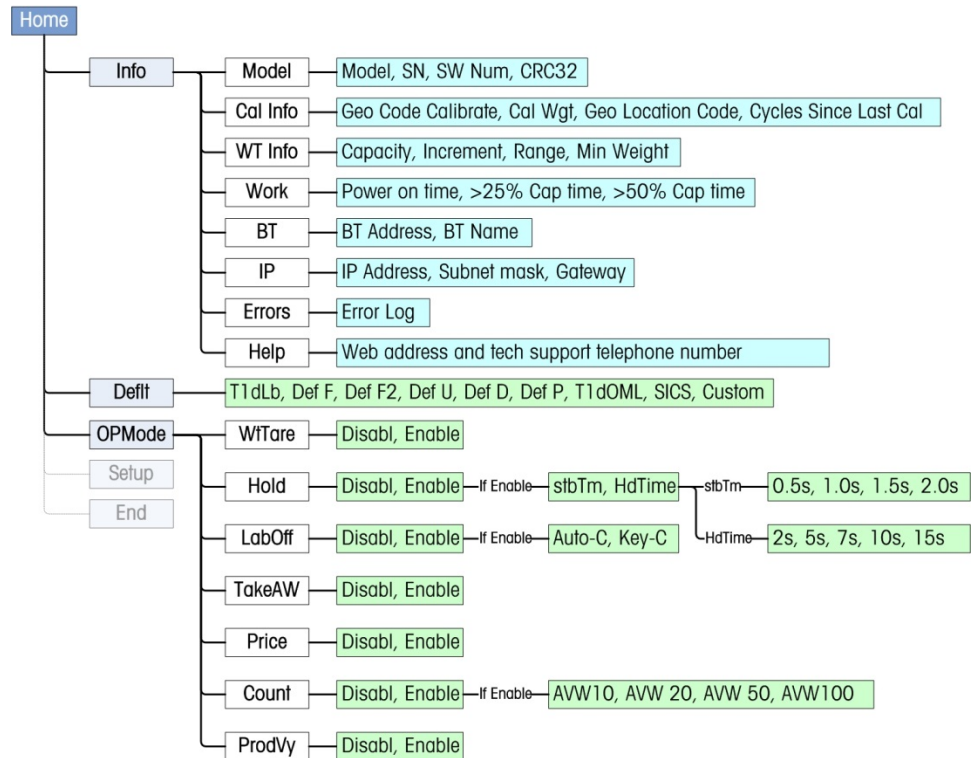

Figure 4-5: Info, Defaults and Operating Mode Menu Structure

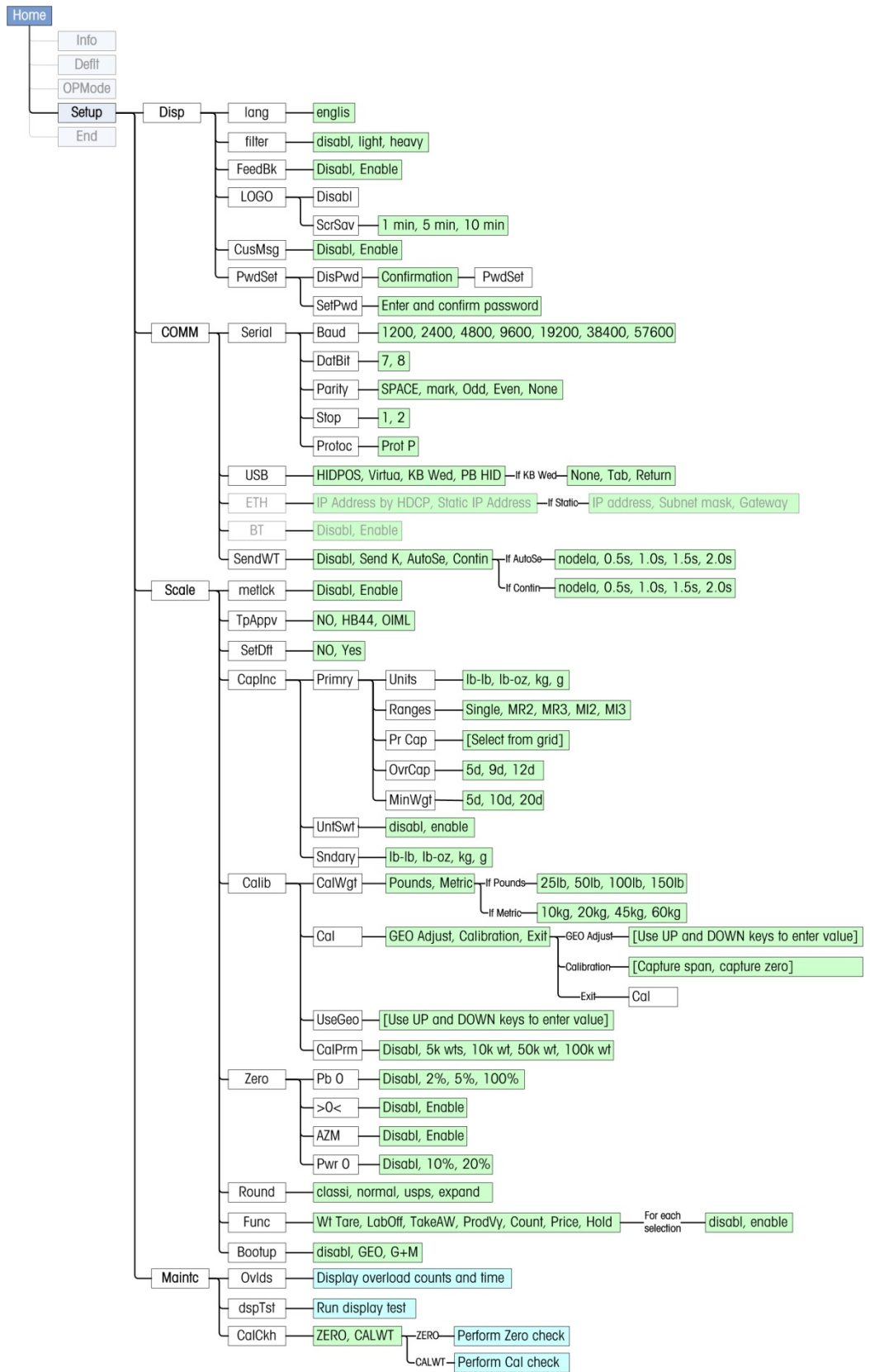

Figure 4-6: Setup Menu Structure

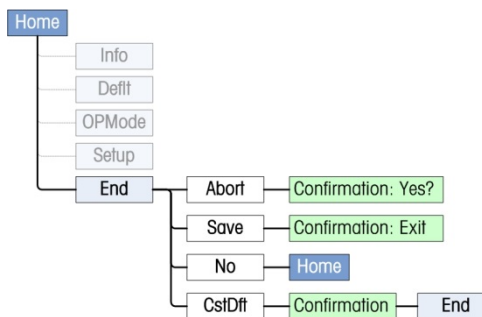
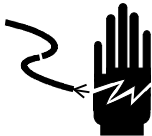



Figure 4-7: End Menu Structure

4.4. Configuration: Overview

	 WARNING
<p>ONLY PERMIT QUALIFIED PERSONNEL TO SERVICE THIS EQUIPMENT. EXERCISE CARE WHEN MAKING CHECKS, TESTS AND ADJUSTMENTS THAT MUST BE MADE WITH POWER ON. FAILING TO OBSERVE THESE PRECAUTIONS CAN RESULT IN BOIDLY HARM.</p>	

The BC scale can be:

- **Customized** by accessing the setup menus and configuring each parameter
- **Preset** to a default configuration which automatically sets all parameters:
 1. **Home > Dfit** provides a default configuration for each of the major carriers, focusing on a serial setup parameters and protocols. Use a default selection if you do not wish to customize the parameter settings; the default setting will automatically enter the parameter settings. It is necessary to save the parameters by accessing the **END** screen and selecting **Save**.
 2. Selecting a **Type Approval** of **None**, **HB44** or **OIML** (at **HOME > Setup > Scale > TpAppv**) then selecting **Yes** at **Home > Setup > Scale > SetDft** will automatically enter the approved capacity and increment parameters for the scale. It is necessary to save the parameters by accessing the **END** screen and selecting **Save**.
- Note that limitations of the 7-segment display mean that a limited set of alpha characters is available. For example, the letter "m" cannot be displayed, and will be replaced with an "n."

4.4.1. Entering Setup Mode

To enter setup, press and hold the UP arrow on the navigation keypad for 5 seconds, until HOME is displayed.

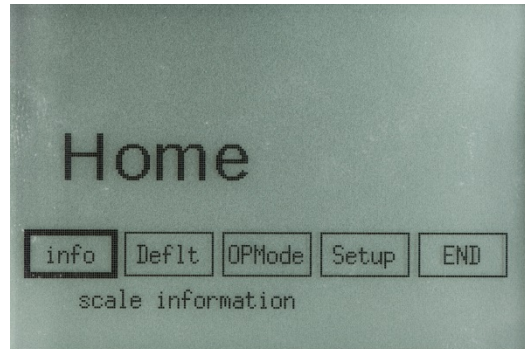

Figure 4-8: Home Screen

To configure the scale, use the navigation keys to scroll to the desired softkey, then press ENTER. The display will show selection softkeys across the bottom of the screen. At the top of the screen, softkeys will appear, representing the various levels of the menu structure.

The Home screen provides the following options. Asterisks (*) indicate sections that can be password-protected.

INFO		Displays scale status information such as full model number, scale calibration weight, capacity and increment size, etc. (Figure 4-5)
Deflt	*	Allows setting of the METTLER TOLEDO defaults, carrier defaults, or a Custom default previous saved from the END menu. (Figure 4-5)
OPMode	*	Configure the availability of modes available to the operator when the M (Mode) softkey is pressed on the weighing screen. Modes include Tare, Count, HOLD, Label offset, etc. (Figure 4-5)
Setup	*	Accesses the setup menu tree (Figure 4-6) where display, communication, scale and maintenance parameters are configured.
END		Save or abandon changes, set a Custom default (Figure 4-7).

4.4.2. Keyboard Shortcuts

- If the cursor is on a softkey representing the currently-selected value, pressing ENTER will move the view to the next higher menu screen.
- Press and hold ENTER to jump directly to the END screen.
- A small arrow at lower right on a screen of selections (see Figure 4-9) indicates that further options may be viewed by scrolling right.
- When the cursor reaches the last item in a row of options, pressing RIGHT will return the cursor to the first item in the list – it wraps around.

4.4.3. Exiting Setup Mode

There are three ways of leaving setup:

- Press ENTER and hold for five seconds. The END screen will appear.
- Press the UP arrow and scroll to HOME, then press ENTER. Scroll to select END and press ENTER. Scroll to select either **Save** or **Abort**, and press ENTER.
- Disconnect the scale from power. Changes will not be saved.

4.4.4. Remote Configuration

The BC scale can also be configured remotely using the METTLER TOLEDO Host Interface. Details on the use of this interface are given in **Appendix D**.

4.5. Configuration: Info

The **info** screen accessible from the **HOME** screen (Figure 4-8) provides important reference and setup information. To exit an information screen, press the UP arrow and highlight either **Info** or **Home**, then press ENTER.

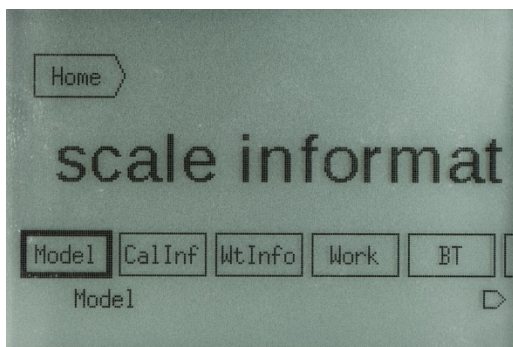

Figure 4-9: Info Screen

Model	Scale information	Includes scale status information including full model number, serial number, calibration weight, capacity and increment size, etc.
Cal Info	Defaults	Allows the selection of METTLER TOLEDO defaults, Carrier Defaults, or a Custom default previous saved from the END screen.
WT Info	Weight information	Displays information about the scale's capacity, increment, ranges and minimum weight settings.
Work	Working time	Shows scale's power on time, and amount of time spent at 25% and 50% capacity.
BT	Bluetooth	Displays the scale's Bluetooth address and device name.
IP	IP Address	Shows the type of IP address (static or DHCP) and, if the address is static, lists IP address, subnet mask and gateway values.
ERRORS	Scale error log	Displays a log of the five most recent scale errors.
Help	Help	Displays the BC scale website address, and technical support telephone number either for METTLER TOLEDO or local dealer.

4.5.1. Model

This screen displays:

- Complete BC model number including all options ordered
- Serial number of the scale
- Software number and version
- Checksum (CRC) calculation

4.5.2. Cal Info

This screen displays:

- GEO Code location for which the scale was last calibrated
- Calibration weight used – the value configured in setup at **Home > Setup > Scale > Cal**
- Min Weight – the number of divisions used to calculate the “Min” value displayed to comply with Metrology requirements

4.5.3. Working Time

This screen displays the amount of time the scale has been in use:

- Power on time, including time when scale is at zero
- Time at >25% of capacity, in seconds
- Time at >50% of capacity, in seconds

4.5.4. BT

This screen displays information about the Bluetooth connection:

- BT Address
- BT Name

4.5.5. Error Log

This screen displays the last five error messages displayed by the scale.

4.5.6. HELP

This screen displays information about service and product assistance resources:

- URL for the scale product web page
- Contact telephone number for METTLER TOLEDO service or local dealership.

4.6. Defaults

Default values for various carriers can be set automatically. Values affected are:

Filter	Baud	ASCII BIT string	Parity	Stop Bits
Protocol	USB	Metrology Lock	Unit Switching	PB Zero
Zero Indicator	AZM	Power-Up Zero	Rounding Mode	

To select a default settings for the Carriers or MT protocol:

1. On the **Home** screen, scroll to the **Defn** softkey and press ENTER.
2. Scroll to the desired default and press ENTER again. The scale will be updated with the parameters, but the change is not immediately saved. Options are:
 - Default: METTLER TOLEDO
 - Def F – FedEx
 - Def F2 – FedEx 2
 - Def U – UPS
 - Def D – DHL
 - Def P – Purolator
 - TLDOML – Toledo OIML
 - SICS – MT SICS
 - CUSTOM – Values saved ast **END > CUSTOM**
3. Scroll up to the **Home** softkey and press ENTER.
4. Scroll to **END** and press ENTER.
5. Scroll to **Save**, press ENTER, and confirm the operation.

4.7. Operating Mode

For a Function to be displayed in the Mode selection screen accessible to the operator, it must first be enabled in setup at **Setup > Scale > Function**, an area protected by the metrology lock; and then enabled from the **Operate Mode** screen (Figure 4-10), which can be password protected on a managers level.

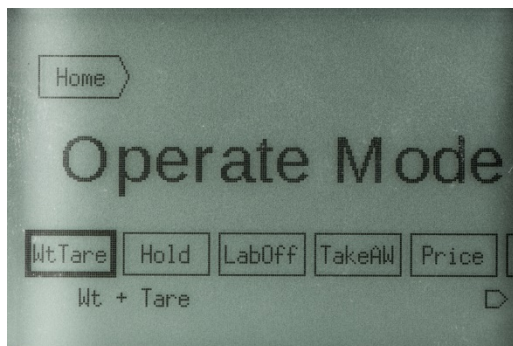

Figure 4-10: Operating Mode Screen

WtTare	Weight and Tare	Allows use of tare function to subtract container weight and display a net weight value
Hold	Hold	Holds the display weight after a large parcel is removed – useful in cases when a parcel on the platter conceals the display
LabOff	Label Offset	Adds an offset for items such as packing lists, added after the parcel is weighed
TakeAW	Take Away	Allows differential weighing – for example, removing letters from a basket
Price	Show Price	Shows price and weight on the display
Count	Bulk Mail / Count	Calculates the Average Piece Weight (APW) to determine a count
ProdVy	Product Verification	Shows differential weight for a packing station, to assist in verifying package contents

- In each of these options, values are communicated using the Toledo Protocol; refer to **Appendix A**.

4.7.1. WtTare

Tare mode is used when the application needs a net weight of contents without container weight. The scale will allow the container to be subtracted from the Gross Weight. The tare value is created by placing the container on the scale and pressing the T soft key. The display will then display an **N** for Net weight.

To disable tare, press the T softkey again when the platter is empty. Tare can also be set to clear automatically, so that so when the scale sees zero gross weight the Tare is cleared. Auto clear is used for a single weighment. Key pad Tare can be used for multiple weighments with the same container. To enable the Tare function, scroll to **WtTare** and press ENTER.

1. Select **Disable** or **Enable**, and press ENTER.

2. If **Disabled** was selected, Exit the screen. Otherwise, the scale will prompt for the type of Tare. Scroll to and highlight either Auto-C (auto-clear) or Key-T (keypad tare).
3. Press ENTER.

4.7.2. Hold

The hold function will retain the displayed weight for a specified length of time after the weight has been removed from the platter. This function is used when scale weight is being recorded manually, and a large box makes it impossible to see the display. To enable this function, access the **Operate Mode** screen (Figure 4-10), scroll to **Hold**, and press ENTER.

1. Select **Disable** or **Enable**, and press ENTER.
2. If **Disabled** was selected, Exit the screen. Otherwise, the scale will prompt for the hold time (**HdTime**) and stable time (**stbTm**).
3. Scroll to **HdTime** and press ENTER. This value determines the amount of time, in seconds, for which the scale will retain the displayed weight after it sees a significant change in weight. Options are:
 - 2 sec
 - 5 sec
 - 7 sec
 - 10 sec
 - 15 sec
 - 20 sec
4. Highlight the desired value and press ENTER.
5. Scroll to **stbTm** and press ENTER. This value determines the amount of time the weight must be steady on the platter (without motion or vibration) before the scale will recognize it as the final weight. Options are;
 - 0.5 sec
 - 1.0 sec
 - 1.5 sec
 - 2.0 sec
6. Highlight the desired value and press ENTER.
7. Press ENTER again to exit the screen.

4.7.3. LabOff

The Label Offset Mode is similar to the Tare mode, except the weight amount is added to the gross weight to give a Gross+ value. Label Offset mode allows a shipper to compensate for any packing labels, box tape, or other items added to the parcel after final weighing for price determination. This is important for Pre-pay and Add scenarios, where Carriers will back-charge for a higher weight than the one originally determined when the parcel was shipped.

The Offset value is determined by placing a sample load on the scale and pressing the **T** softkey. The display will display **G+** (for Gross Plus weight).

The offset can be disabled by pressing the **T** soft key button with nothing on the platter, or it can be set to Auto-Clear so when the scale sees zero gross weight the Offset is cleared. Auto-clear is used for a single weighment. Keypad Tare can be used for multiple weighments using the same container. To enable the label offset function, scroll to **LabOff** and press ENTER.

1. Select **Disable** or **Enable**, and press ENTER.
2. If **Disabled** was selected, Exit the screen. Otherwise, the scale will prompt for the type of clearing function – **Auto-C** or **Key-C**.
3. Select the desired option and press ENTER. Press ENTER again to exit the screen.

4.7.4. TakeAW – Differential Weighing

Differential weighing is designed to accommodate a container of letters, where the whole container can be placed on the scale, and the weight of each letter is communicated as it is removed from the container. If necessary, the container can be tared. To Enable the differential weighing function, scroll to **TakeAW** and press ENTER.

1. Select **Disable** or **Enable**, and press ENTER.
2. If **Disabled** was selected, Exit the screen. Otherwise, press the Enabled softkey a second time to exit the screen.

4.7.5. Price

When the price mode is enabled, the scale will accept communication of the calculated total price of the weighment from a local PC. The scale will display the weight and price on the operator display and the remote customer display, if one is attached. **This feature is only available in MT-SICS protocol.** To enable the label offset function, scroll to **Price** and press ENTER.

1. Select **Disable** or **Enable**, and press ENTER.
2. If **Disabled** was selected, Exit the screen. Otherwise, press the Enabled softkey a second time to exit the screen.

With Price mode enabled, the scale will look for a command from the PC, such as **GSPMNY"xxxxxx**, where xxxxxx denotes the price to be displayed, including the currency symbol and decimal or comma. For example, if the PC sends **GSPMNY"\$12.40,"** \$12.40 will be displayed. Refer to **Appendix E** for additional details. The price will be displayed until the scale returns to zero.

4.7.6. Count

Bulk Mail / Counting mode allows for a sample of identical parts or letters to be weighed, and an Average Piece Weight (APW) calculated to four decimal places. As more identical parts are added to the scale, the scale will calculate the number of parts by dividing the Net weight by the APW. To enable the counting function, scroll to **Count** and press ENTER.

1. Select **Disable** or **Enable**, and press ENTER.

2. If **Disabled** was selected, Exit the screen. Otherwise, the scale will prompt for the number of pieces used to calculate the average piece weight. Options are:
 - AVW 10
 - AVW 20
 - AVW 50
 - AVW 100

4.7.7. ProdVy

The product verification mode is designed for Warehouse packing stations where verifying the weight of each item placed in to the box during packaging helps eliminate packing errors. The mode will communicate the gross weight and the incremental weight from the last stable weight. The incremental weight can be compared to the database weight for compliance. To enable the product verification function, scroll to **ProdVy** and press ENTER.

1. Select **Disable** or **Enable**, and press ENTER.
2. If **Disabled** was selected, Exit the screen. Otherwise, press the Enabled softkey a second time to exit the screen.

4.8. Setup: Overview

The Setup screen (Figure 4-11) offers four options.

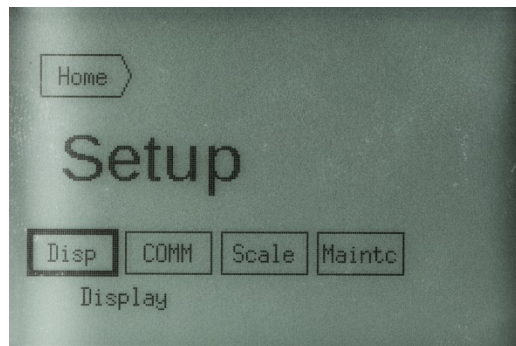

Figure 4-11: Setup Screen

Disp	Display	Sets operator interface parameters such as Language,
COMM	Communications	Sets parameters for Serial USB, Ethernet, etc.
Scale	Scale configuration	Configures scale metrology calibration
Maintc	Maintenance options	Accesses scale information useful for troubleshooting and preventive maintenance

4.9. Setup: Display

The **Display** screen allows the scale's user interface to be configured. It includes six options.

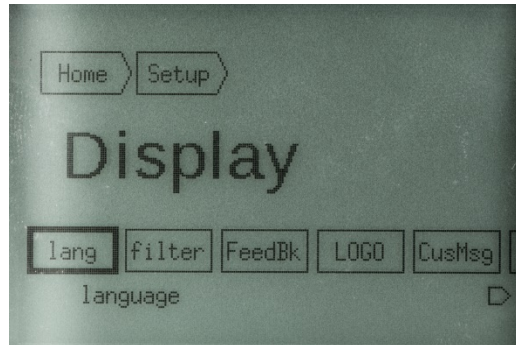

Figure 4-12: Display Setup Screen

lang	Language	Sets the scale's display language
filter	Filter	Sets the filter value used to compensate for vibration
FeedBk	Feedback	Configures the visual feedback used to indicate that an input has been accepted
LOGO	Screen-saver	Enables the display of the screen-saver logo
CusMsg	Custom message	Enables the display of a custom message
PwdSet	Password set	Used to set the manager's password

4.9.1. Language

Five standard languages are supported in the BC scale series:

- English
- Spanish - Español
- French - Français
- German - Deutsche
- Chinese.

In the **Language** screen (Figure 4-13) select the desired language and press ENTER. Each option should be shown in its own language. Thus, Spanish is displayed as **Español** with softkey description **ESPANL**.

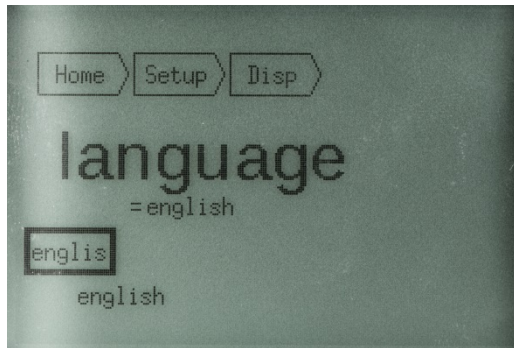

Figure 4-13: Language Setup Screen

If you the wrong language is selected, to return to the Language screen, either:

- Scroll UP to the last (right-most) softkey in the location display at the top of the screen, and press ENTER. Repeat until the Language screen appears – each option will still display in its own language. Scroll to the correct language softkey and press ENTER.

or

- Power down the scale by unplugging the power supply or USB cable. Parameter settings not yet saved at **END > Save** will be cancelled.

4.9.2. Filter

This setting configures the vibration noise filter used to determin weight stability on the scale. The BC disregards environmental vibrations that affect the weighing accuracy, depending on the filter setting. If the scale display reading is not stabilized while a steady load is on the scale, then increase the filter setting to **LIGHT** or **HEAVY**. A higher filter setting will take a longer time to reach a stable weight. The default setting is **NONE**, and this is appropriate for most applications

To configure the filter setting:

1. Access Home > Setup > Display > Filter.
2. Select the desired option:
 - None
 - Light
 - Heavy
3. Press ENTER to confirm. Press ENTER again to leave the screen.

4.9.3. Feedback

The BC scale can provide a visual indicator when a navigation keypad press has registered with the scale. The indicator is a small circle that appears at the bottom right of the screen (Figure 4-14). In weighing mode, it is directly below the ZERO softkey. The option can be **Disabled** or **Enabled** at **Home > Setup > Display > Feedback**.

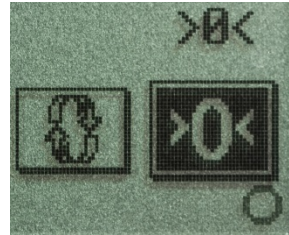

Figure 4-14: Keypress Feedback Symbol

4.9.4. Logo

The BC scale can display a logo as a screen-saver. This can be disabled or enabled, and an idle time configured that determines how long the scale will wait before switching to screen-saver mode. The option can be configured at **Home > Setup > Display > LOGO**.

The idle time can be set to:

- 1 minute
- 5 minutes
- 10 minutes

The logo image must be a monochrome bitmap measuring 240 by 160 pixels. A special SICS program is needed to download a custom logo image. Refer to **Appendix E** for details.

4.9.5. Custom Message

The BC scale can display a custom message at the top of its Weighing Mode screen. To enable a message, access **Home > Setup > Display > CusMsg**.

The message to be displayed must be downloaded to the scale using a SICS command:

```
GSPMSG "xxxxxx-AAAAAA- CCCCC"
```

Refer to **Appendix E** for further instructions on how to load a message.

4.9.6. Password

- Before entering a password, write down the keystroke sequence for future use. Passwords are created using the UP, DOWN, RIGHT, and LEFT arrow keys. Keep the password in a safe location for future use.

A manager's password can be set in the BC scale, to limit access to the program modes. In the HOME page, the DEFAULTS, OPERATOR MODE, and SETUP soft keys are password protected. Only INFORMATION and END are not password protected. A password consists of 1 to 6 key strokes on the navigation keys (UP, DOWN, RIGHT, LEFT).

1. To set a password, access Home > Setup > Display > PwdSet.

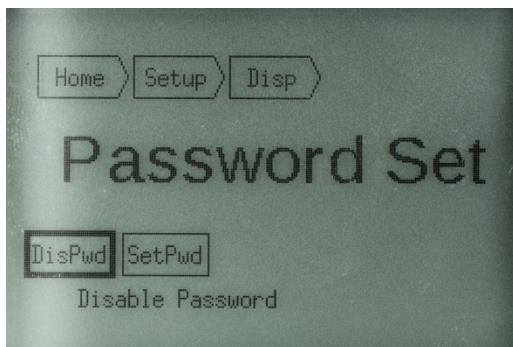

Figure 4-15: Password Set Screen

2. Select either **DisPwd** (disable) or **SetPwd** (set password).
3. If **DisPwd** was selected, a confirmation screen will appear. Press ENTER to confirm, or any arrow key to cancel. To confirm disabling the password, press ENTER and exit the screen by scrolling up to the location line, selecting a previous page, and pressing ENTER.
4. If **SetPwd** was selected, a popup window will appear for password entry.
5. If **SetPwd** was selected, a popup window will appear for password entry.

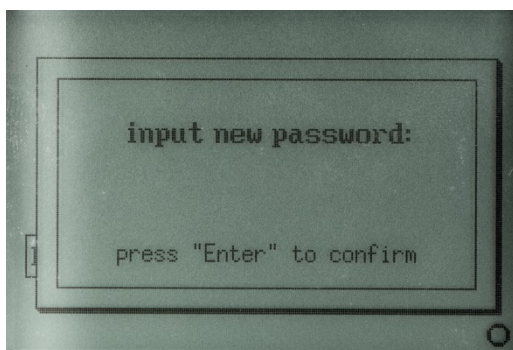

Figure 4-16: Password Entry Screen

6. Use the arrow keys to enter a password sequence of 1 to 6 key-presses; press ENTER to assign the password.
7. A confirmation prompt will appear; re-enter the password and press ENTER.

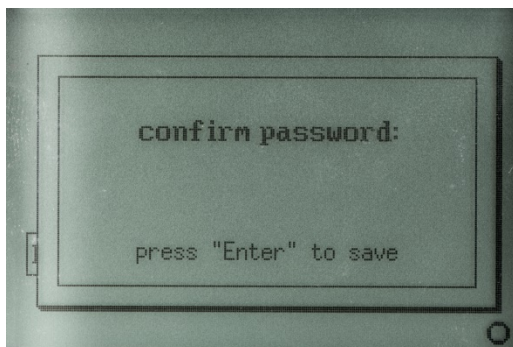

Figure 4-17: Password Confirmation Screen

8. If the passwords **do not** match, the Password Entry screen will reappear with the message **Not same, please retry!** Repeat the process from the beginning.
9. If the passwords **match**, the initial password screen (Figure 4-15) will reappear.
10. To accept the password and exit the screen, use the UP arrow to highlight an icon in the location line at the top of the screen, then press ENTER. The password will not be finalized until all changes are saved at **Home > END > Save**.
11. To exit either password entry screen **without creating a password**:
 - Either: Visit **Home > End > Save** and, **Abort**, and confirm. Changes made in any area of Setup will not be saved, and the weighing screen will reappear.
 - Or: Cycle power to the scale. Changes made in any area of Setup will not be saved.

4.10. Setup: Communications

The **COMM** screen allows the scale’s communication settings to be configured. It includes five options.

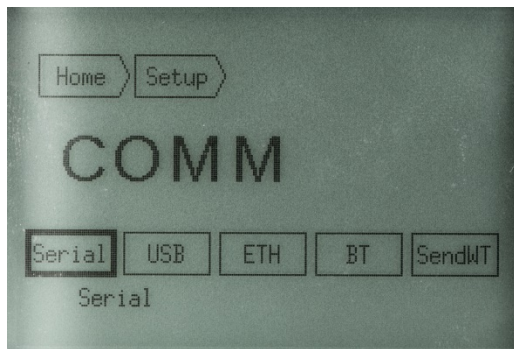

Figure 4-18: Communications Setup Screen

Serial	Serial settings	Sets parameters such as baud rate and data bits
USB	USB settings	Sets USB options
ETH	Ethernet settings*	Sets Ethernet address settings. (Requires additional hardware)*
BT	Bluetooth settings*	Sets Bluetooth connection settings*
SendWT	Sends weight data	Weight data can be sent, either by a keypad press or continuously

* Ethernet and Bluetooth options are not currently available

4.10.1. Serial

The SERIAL program block is used to configure RS-232 communications including Protocol used. This set up will also apply to the Virtual Serial settings in USB applications (section 4.10.2).

- **IMPORTANT:** For successful communication between the scale and a PC, both the serial parameters and the protocols in scale and PC must match. The weight request command is case sensitive. Thus, if a weight “request” command is a capital **W**, sending a lower case **w** will not get a weight response from the scale.

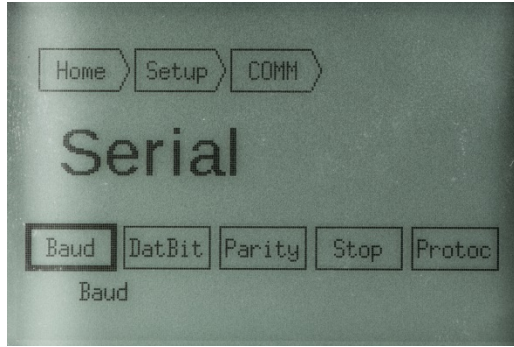

Figure 4-19: Serial Communications Setup Screen

4.10.1.1. Baud

Sets the baud rate for the RS-232 connection. This is the speed, in bits per second, at which data is transmitted.

1. In the **Serial** screen, scroll to **Baud** and press ENTER.
2. Scroll to desired baud rate to highlight it and press ENTER to accept the value. Options are:

1200	2400	4800	9600
19200	38400	57600	
3. Press ENTER again to return to **Serial** page, or press the UP arrow and highlight the **Serial** softkey, then press ENTER.

4.10.1.2. ASCII Data Bits

Sets the number of data bits that make up an ASCII character for the RS-232 connection. Options are seven or eight data bits.

1. In the **Serial** screen, scroll to **DatBit** and press ENTER.
2. Scroll to the desired value to highlight it, and press ENTER to accept the value. Options are:
 - 7
 - 8
3. Press ENTER to select the value.
4. Press ENTER again to return to the **Serial** page, or press the UP arrow and highlight the **Serial** softkey, then press ENTER.

4.10.1.3. Parity

Sets the parity option for the RS-232 connection. Parity is an error checking mechanism. The setting selected here depends on the configuration of the ASCII Data Bits:

- If **ASCII** = 7, then typical **Parity** options are **Space**, **Mark**, **Odd** and **Even**.
- If **ASCII** = 8, then **Parity** is typically set to **None**.

To configure parity:

1. In the **Serial** screen, scroll to **Parity** and press ENTER.

2. Scroll to the desired value to highlight it, and press ENTER to accept the value. Options are:
 Space mark Odd Even None
3. Press ENTER to select the value.
4. Press ENTER again to return to the **Serial** page, or press the UP arrow and highlight the **Serial** softkey, then press ENTER.

4.10.1.4. Stop Bit

Select the number of stop bits to be transmitted for each ASCII character in an RS-232 connection.

1. In the **Serial** screen, scroll to **Stop** and press ENTER.
2. Scroll to the desired value to highlight it, and press ENTER to accept the value. Options are:
 - 1
 - 2
3. Press ENTER to select the value.
4. Press ENTER again to return to the **Serial** page, or press the UP arrow and highlight the **Serial** softkey, then press ENTER.

4.10.1.5. Protocol

Select a pre-configured set of scale commands for an RS-232 connection. Protocols are configured in the factory according to your ordering information. This screen permits a pre-configured protocol to be selected.

1. In the **Protocol** screen, scroll to **Baud** and press ENTER.
2. Scroll to desired selection to highlight it and press ENTER to accept the value. Options are:

disabl	toledo	mt-sic	Prot F	Prot U	Prot P
(Disabled)	(METTLER TOLEDO)	MT-SICS	FedEx	UPS	Purolator
3. Press ENTER again to return to **Serial** page, or press the UP arrow and highlight the **Serial** softkey, then press ENTER.

4.10.2. USB

The USB screen allows various types of USB communication to be configured. These include HIDPOS, Virtual Serial, and Keyboard Wedge. The option chosen here will also apply to Virtual Serial in the USB applications.

The **Home > Setup > Communication > USB** screen includes the following options:

HIDPOS HIDPOS is a standard Microsoft Human Interface Device protocol for Point-of-Sale equipment which includes a scale. If the software on the PC is programmed for HIDPOS, the connection is "Plug and Play" and no additional drivers are needed. In this case, the scale operates as a USB peripheral to the PC.

To configure the parameter from the **USB** screen, scroll to **HIDPOS** and press ENTER. To exit the page, press ENTER again to go back to the **USB** screen, or press the UP arrow and select the desired page and press ENTER.

- Virtua** The Virtual USB setting enables communication over a USB cable using a serial protocol. No additional cabling or hardware adapter is needed, but a special software driver is required for the PC. Refer to **Appendix C** for details.
- To configure the parameter from the USB screen, scroll to VIRTUA (Virtual Serial) and press ENTER. To exit the page, press ENTER again to go back to the USB screen, or press the UP arrow and select the desired back page and press ENTER. Serial settings and protocol will apply. See SERIAL program block above.
- KBWed** The BC scale has the flexibility to configure the scale to operate like a Keyboard without any additional cabling or hardware. In this setting, the scale is configured as a keyboard in the HID of the PC. Weight is effectively “typed” into any software program from the scale, as if the operator was typing in the weight using a keyboard.
- This setting is used in conjunction with the **SendWT** (send weight) command accessible at **Home > Setup > COMM**. The scale can be configured for weight to be sent by pressing the keypad, upon sensing a stable weight, or sent continuously.
- Once the **KD Wedge** screen (Figure 4-20) is accessed, a further option appears: an additional character can be designated after the weight data is typed, to index to the next space in the program. Options are **None**, **Tab** and **Return**.

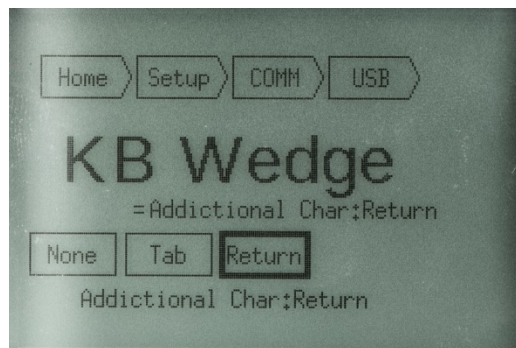

Figure 4-20: Keyboard Wedge Configuration Screen

4.10.3. Ethernet

The Ethernet option is not currently available.

4.10.4. Bluetooth

The Bluetooth option is not currently available.

4.10.5. SendWT

The Send Weight function is typically used with Keyboard Wedge, or serial communication in the **Toledo** protocol. The function activates a communication message when

- The Send Weight softkey is selected and pressed on the weighing screen,
- or Automatically when the scale detects a stable, non-zero weight,
- or as a continuous output.

In the SendWT screen, select the type of output and press ENTER. Options are:

Disabl	Disable	Disables the Send Weight function.
Send K	Send Soffkey 	The Send icon will appear at the left of the weighing screen. Manually send the current scale weight by scrolling to the icon and pressing ENTER.
AutoSe	Auto Send	Sends the weight value whenever a non-zero stable weight is detected on the scale. The delay time after stability is detected must be selected from the following options: <ul style="list-style-type: none"> • nodela (send immediately) • 0.5 sec • 1.5 sec • 2.0 sec
Contin	Continuous	Sends the weight value continuously at a specified time interval. Select the interval from the following options: <ul style="list-style-type: none"> • 0.1 sec • 0.2 sec • 0.5 sec • 1.0 sec • 1.5 sec

4.11. Setup: Scale

The Scale setup menu system allows the user to configure parameters that determine the scale's performance. If the metrology lock is in place (enabled at **Home > Setup > Scale > metlck**). This lock can only be bypassed using the method detailed in section 4.2.

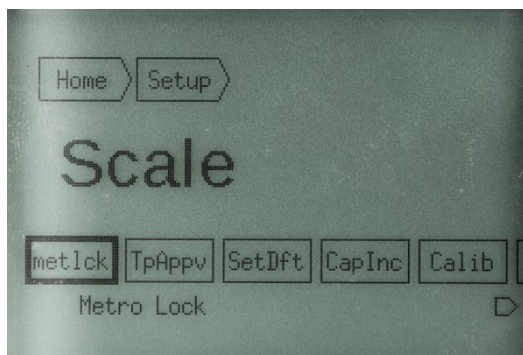

Figure 4-21: Scale Setup Screen

The following options are available from this screen:

metlck	Metrology lock	Enable or disable the metrology lock, which prevents modification of the Scale setup parameters.
---------------	----------------	--

TpAppv	Type approval	Selects the type of approval for the scale.
SetDff	Set default	Populates the default capacity and increment parameters based on the Type Approval.
CapInc	Capacity and Increment	Sets the primary units, ranges, and increments, and the capacity and increment sizes for each range.
Calib	Calibration	Sets the Geo code and calibrates the scale
Zero	Zero	Configures the scale's zero functionality.
Round	Rounding	Determines the rounding methods used.
Func	Functions	Enables the operating modes that will appear on the Mode selection screen (refer to Chapter 3).
BootUp	Boot-up menu	Configures the scale's boot-up behavior.

- Settings selected in the Scale Setup block are not saved until **Home > END > Save** has been selected and confirmed.

4.11.1. Metrology Lock

The Metrology Lock can be disabled or enabled. If it is enabled, the Cal button SW2 must be pressed to obtain access to the **Home > Setup > Scale** menu items described in this section. Access is ended by accessing the **Setup** screen, or anywhere higher in menu structure. To re-enter the **Scale** menu system, the Cal button must be pressed again.

It may be acceptable to disable the Metrology Lock for easier access to applications that are not Legal-for-Trade.

- **IMPORTANT:** Check with local authorities if your application is Legal-for-Trade, and if you are required to have the Metrology lock sealed to prevent tampering.
 1. To set the metrology lock, access **Home > Setup > Scale > metlck**.
 2. Highlight the desired selection – either **Disabl** or **Enable**.
 3. Press ENTER to make the selection, then press ENTER again to return to the **Setup** screen.

4.11.2. Type Approval

The Type Approved parameters allow selection of the approval criteria. It is used in conjunction with the **Set Default** parameter (section 4.11.3) to populate the remaining scale setup parameters.

1. To set the type approval, access **Home > Setup > Scale > TpAppv**.
2. Highlight the desired selection:
 - **None** Scale not approved
 - **HB44** Follows Handbook 44, the requirements for the National Type Evaluation Program (NTEP), for the USA, and Metrology Canada, for Canada.
 - **OIML** Follows requirements of the International Organization of Legal Metrology's R76 model regulations for member states, such as countries of the European Community (EC)
3. Press ENTER to confirm the selection, then press ENTER again to return to the **Setup** screen.

4.11.3. Set Default

Set Default simplifies configuration by setting the remaining scale setup parameters, depending on the type approval selected (4.11.2). Once this parameter is enabled by selecting **Yes**, default capacities and increments are set. However, the scale parameters can still be customized.

Parameters are not saved until the **Home > End > Save > [confirm]** sequence is complete. To abandon the change, select **Home > End > Abort**, or power down the scale without saving.

1. To set a default configuration, access **Home > Setup > Scale > SetDfl**.
 2. Highlight the desired selection – either **NO** or **Yes**.
 3. Press ENTER. A pop-up window will appear with the message **build loaded ok!** Press ENTER again to exit to the **Home > Setup > Scale** screen.
- If **Type Approval** is changed and **Set Default** set to **NO**, a save error will be displayed when **Home > End > Save** is selected. Either Abort the changes, or return to **Set Default** and select **Yes**. In this case, check all parameters at **Home > Setup > Scale > CapInc**.

4.11.4. Capacity and Increment

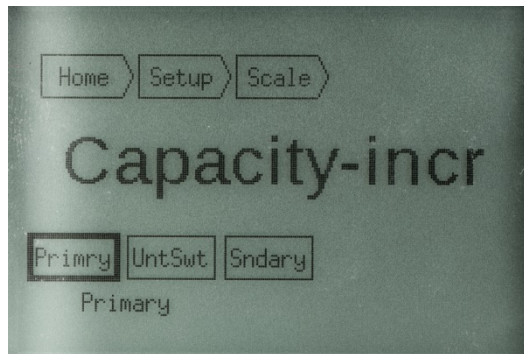

Figure 4-22: Capacity and Increment Setup Screen

The Capacity and Increment parameters set the scale's metrological configuration, including primary and secondary units if unit switching is enabled. To set these parameters, access **Home > Setup > Scale > CapInc**.

In the Capacity and Increment screen, select from:

Primry	Primary units	Sets the scale's primary units of measure
UntSwf	Unit switching	Enables switching between primary and secondary units
Sndary	Secondary units	Sets the scale's secondary units of measure

4.11.4.1. Primary Units

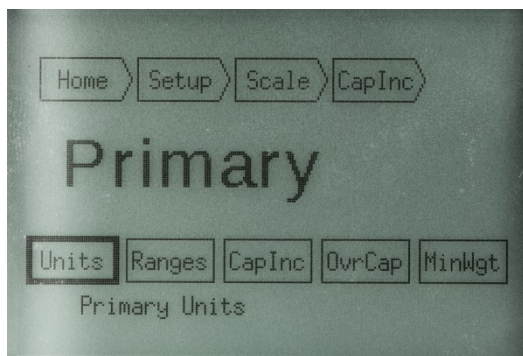

Figure 4-23: Primary Units Setup Screen

Here, the primary units, number of ranges, capacity and increment size, over-capacity value and minimum weight parameters can be set.

In the **CapInc > Primry** screen, highlight the desired softkey and press ENTER. The following options are available:

Units	Units	Sets the primary units of measure
Ranges	Number of ranges	Sets the number of ranges
Pr Cap	Capacity and increment	Sets capacities and increments for the configured ranges
OvrCap	Over capacity	Sets the weight value at which the scale will blank, or display the overcapacity symbol
MinWgt	Minimum weight	Sets the minimum weight that will display on the weighing screen

4.11.4.1.1. Units

Options for primary weight units are:

- Lb-Lb (Example: 45.85 lb.)
- Lb-oz (Example: 45 lb. 13.6oz)
- Kg (Example: 20.840 kg)
- G (Example: 20840 g)

4.11.4.1.2. Ranges

Options for a single range, multiple ranges, or multiple increments. Options are:

Single	Single range
MR2	Two ranges
MR3	Three ranges
MI2	Two intervals
MI3	Three intervals

Capacity and increment selections for the configured range/s or intervals are made at **Home > Setup > Scale > CapInc > Prmry > PrCap** (section 4.11.4.1.3).

4.11.4.1.3. Capacity and Increment

When this screen is accessed, a chart of options will display, with contents determined by the range and increment settings made at **Setup > Scale > CapInc > Prmry > Range**. The **Cancel** button will be highlighted.

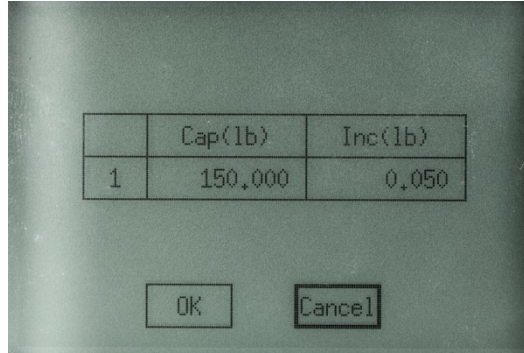

Figure 4-24: Capacity and Increment Setup Screen

1. Press the UP arrow to access the first cell of the chart, then use the arrow keys to select the values to be modified.
2. With the cell highlighted, press ENTER. The last digit will be highlighted.
3. Use the UP or DOWN arrow to increase or decrease the value.
4. Use the LEFT or RIGHT arrow to move to the previous or next value, and use UP and DOWN to change it.
5. When all digits are at the desired value for the block, press ENTER. The highlight will disappear from the selected digit.
6. Use the arrows keys to move to the next block and press ENTER to access the digits. Repeat the modification process described in steps 2 to 5.
7. When all values are set for all ranges, use the DOWN arrow to highlight OK and press ENTER. The **Primary** screen will reappear.

Default values for these parameters are shown in Table 4-1.

Table 4-1: Capacity and Increment Default Values

W&M Approved	BC-15	BC-30	BC-3L	BC-60	BC6L	BC-150
No	30 x 0.005 lb	7 x 0.005 lb 70 x 0.02 lb Multi-Range	7 x 0.005 lb 70 x 0.02 lb Multi-Range	60 x 0.02 lb 150 x 0.05 lb Multi-Interval	5 x 0.05 lb 25 x 0.05 lb 150 x 0.1 lb Multi-Interval	150 x 0.05 lb 300 x 0.1 lb Multi-Range
HB44	15 lb x 0.1 oz 30 lb x 0.2 oz Multi-Interval	7 lb x 0.1 oz 7 lb x 0.2 oz Multi-Interval	3 lb x 0.05 oz 7 lb x 0.1 oz 70 lb x 0.2 oz Multi-Interval	150 x 0.05 lb Single Range	10 lb x 0.1 oz 70 lb x 0.2 oz 149 lb x 0.5 oz Multi-Range	150 x 0.05 lb 300 x 0.1 lb Multi-Range
OIML	3 x 0.001 kg	15 x 0.005 kg	3 x 0.001 kg	60 x 0.02 kg	30 x 0.01 kg	60 x 0.02 kg

W&M Approved	BC-15	BC-30	BC-3L	BC-60	BC6L	BC-150
	15 x 0.005 kg Multi-Interval	30 x 0.001 kg Multi-Interval	6 x 0.002 kg 35 x 0.01 kg Multi-Interval	Single Range	Single Range	150 x 0.05 kg Multi-Range

4.11.4.1.4. Over-Capacity

This parameter sets the high weight value at which the scale's display will blank, or show the over-capacity symbol, as well as the low weight value at which the display will blank, or show the under-capacity symbol. Options are expressed as divisions in the increment size for the range:

- 5d** Five divisions
- 9d** Nine divisions
- 12d** Twelve divisions

4.11.4.1.5. Minimum Weight

This parameter sets the minimum weight that the scale will display for the capacity and increment size. Postal applications may have different minimum weight requirements than retail applications.

Example: Max: 15/30 kg **Min 25 g** e = 5/10 g

Options are expressed as divisions in the increment size for the range:

- 5d** Five divisions
- 10d** Ten divisions
- 20d** Twenty divisions

4.11.4.1.6. Unit Switching

- The secondary unit softkey will only display on the weighing screen if Unit Switching is enabled.

The **UnitSwit** parameter can be set to **disable** or **Enable**.

4.11.4.1.7. Secondary Units

This parameter sets secondary units for the scale capacity. The scale converts primary units into secondary units. The maximum capacity may not be a whole number; the converted increment size is a factor of **1**, **2** or **5**, and is equal to or less than the primary unit size.

Options for the **Sndary** parameter are:

- Lb-Lb (Example 45.85 lb.)
- Lb-oz (Example 45 lb. 13.6oz)
- Kg (Example 20.840 kg)
- g (example: 20840 g)

4.11.5. Calibration

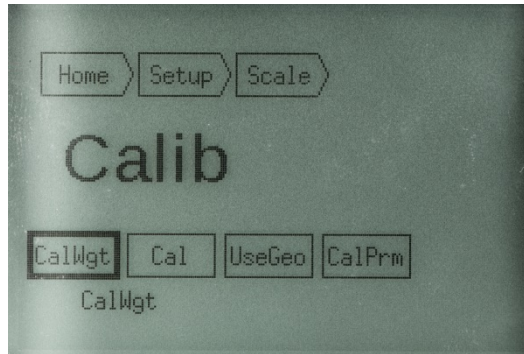

Figure 4-25: Calibration Setup Screen

The parameters set from the **Calibrate** menus include the following:

- CalWgt** Calibration weight
- Cal** Perform calibration
- UseGeo** Use the Geo code for the scale's location
- CalPrm** Calibration prompt for quality control

4.11.5.1. Calibration Weight

- The versatility of the BC scale allows it to be configured for a primary unit of pounds, but be calibrated with a kg test weight.

This parameter sets the size of the weight used to calibrate the scale.

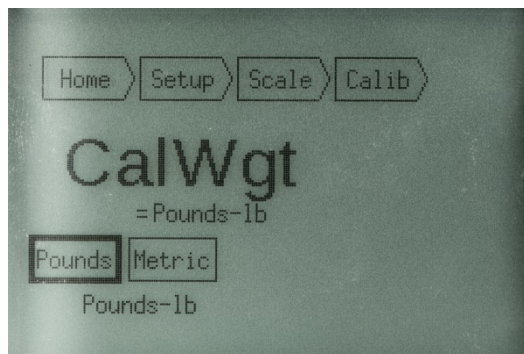

Figure 4-26: Calibration Weight Setup Screen

Select either **Pounds** or **Metric**, then press ENTER. Depending on which option was selected, a calibration weight selection screen will appear. Figure 4-27 shows the screen displayed when **Pounds** is selected.

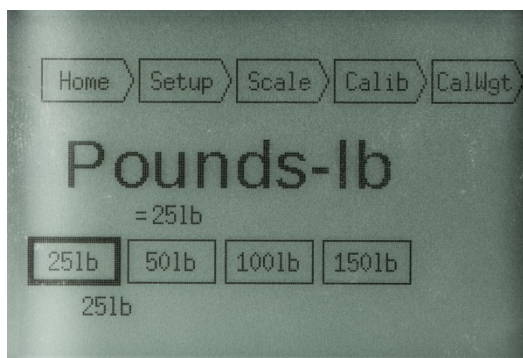

Figure 4-27: Calibration Weight Selection Screen, Pounds

Scroll to the desired weight and press ENTER to return to the **CalWgt** screen.

Table 4-2: Calibration Weight Options

Scale	Units	Cal 1	Cal 2	Cal 3	Cal 4
BC-15	Pounds-lb.	5	10	20	30
	Metric-kg	2	5	10	15
BC-30/3LU	Pounds-lb.	10	25	50	70
	Metric-kg	5	10	20	30
BC-60/6LU	Pounds-lb.	25	50	100	150
	Metric-kg	10	20	45	60
BC-150U	Pounds-lb.	30	50	100	300
	Metric-kg	15	20	45	150

4.11.5.2. Calibration

Access this screen to set the Geo code for the calibration location, and perform scale calibration.

- Changes made here will be saved immediately once the calibration sequence is complete. The scale will automatically save the calibration data, exit setup mode, and reboot. The End program block will not be displayed after calibrating the scale.
 - **Note:** If the calibration sequence is the end of the programming process, make sure the Metrology lock is **Enabled** for Legal-For-Trade applications. To check this, attempt to access **Home > Setup > Scale**.
 - Refer to **Appendix F** for a table of areas and corresponding Geo codes.
1. When the **Calibration** screen is first accessed, the **GEO Adjust** softkey will be highlighted. (If it is not highlighted, scroll to it using the arrow keys).

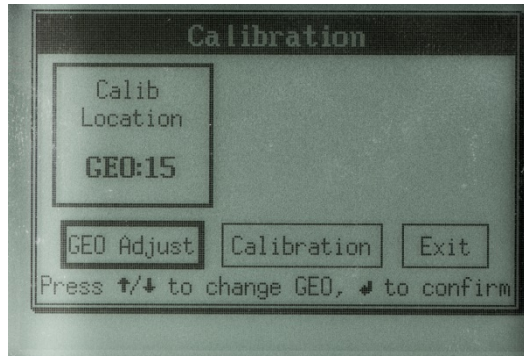

Figure 4-28: Geo Adjust Screen

2. Press the UP or DOWN key to adjust the GEO code value. When the correct value is shown, press ENTER to accept it. Refer to **Appendix F** for a table of locations and corresponding GEO codes.
3. Scroll to the Calibration softkey and press ENTER to start the calibration sequence.
4. The scale will request **Start Calibration, please Empty scale, then Press ENTER**.

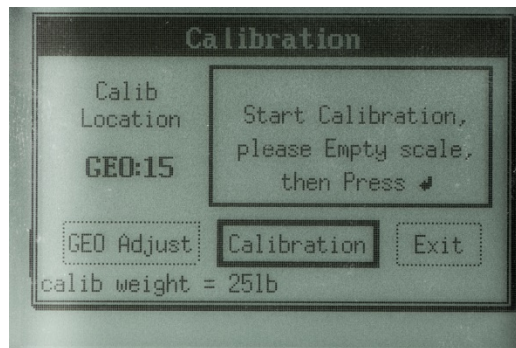

Figure 4-29: Start of Calibration Sequence

5. Ensure that the platter is on the sub-platter, there is no weight or debris on the platter, and there is nothing touching the platter. Once the above items are confirmed, press the ENTER key. The scale will capture zero.
6. Now the scale will request to **Put Load, then Press ENTER**. The calibration weight value is shown at lower left of this screen. The scale will capture span.

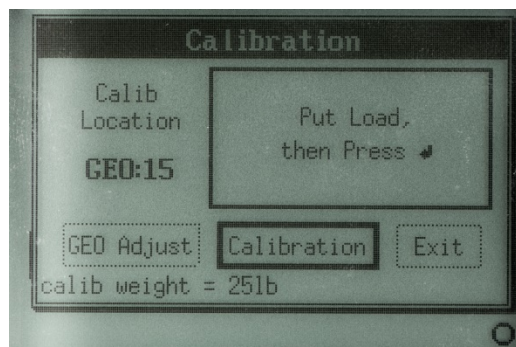

Figure 4-30: Calibration Sequence – Place Load

7. The scale will request **Empty Scale again, then Press ENTER**. Remove weight from the scale platter and press ENTER.

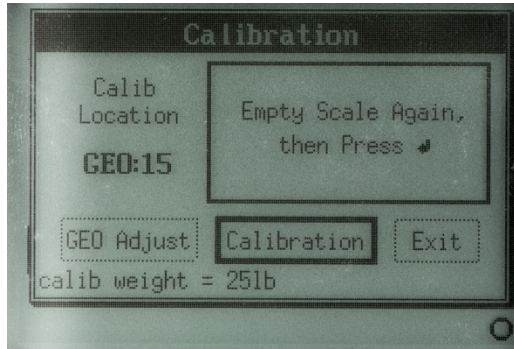

Figure 4-31: Calibration Sequence – Empty Scale Again

8. The scale will display a status message – **Calibration was OK**.

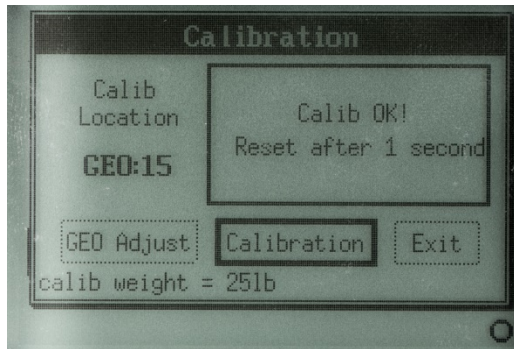

Figure 4-32: Calibration Sequence Successful

9. The scale will count down a few seconds, and then reboot to save the calibration parameters.
 - To exit during the process described above, use the arrow keys to highlight EXIT, then press ENTER. If GEO code setting or the calibration sequence is underway, it must be completed. To exit immediately during either the GEO setting or calibration sequence, power down the scale and reboot it.

When the scale powers back up, check the accuracy of the scale. Verify zero and span using test weights. Place the test weight at multiple locations on the platter.

Refer to section 4.15 for information on sealing the scale for Legal-for-Trade applications.

4.11.5.3. Use GEO

- The METTLER TOLEDO GEOCAL procedure, which prompts for the Geo-Code update on the first power up, uses the USEGEO parameter.

In remote areas, it is expensive to send a service technician to the scale’s location. The **Use GEO** function will update the GEO-code value for a location other than the calibration site. In countries where W&M authorities allow this procedure, a certified technician can:

- Set the GEO Code for the calibration location.
- Calibrate the scale.

- Reset the Geo code for the point of use location.
- Seal the scale and fill out proper documentation.
- Ship the sealed scale to the remote point of use location.

The USEGEO simplifies the resetting of the Geo-code while keeping record of the original calibration GEO Code. Values can be viewed at **Home > Info > Cal Info**.

To configure the parameter:

1. In the Calibration setup screen (Figure 4-25), scroll to **UseGeo** and press ENTER.
2. A numeric box will appear on screen.

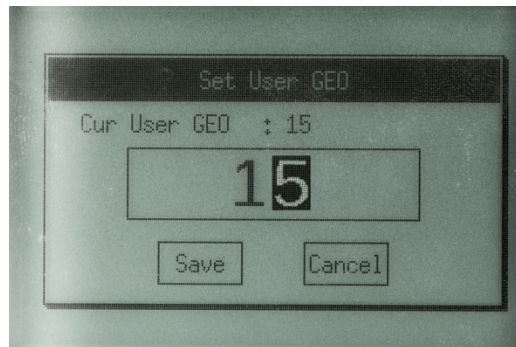

Figure 4-33: Use Geo Setup Screen

3. The right digit will be highlighted, press the UP or DOWN arrow to increase or decrease the value. Once the correct digit is shown, press the LEFT or RIGHT arrow to scroll to the tens digit.
 - The Geo code range is 00 to 31. The tens digit will display a **3** only if the ones digit is **0** or **1**.
4. Update the tens digit in the same way and press ENTER to accept the value.
5. Press the DOWN arrow and scroll to the **Save** softkey. Press ENTER to confirm the setting. The **Calib** screen will display.
 - Refer to Chapter 2 for a table of areas and corresponding Geo codes.

4.11.5.4. Cal Prompt

The **CalPrm** softkey allows a message to be set, to remind an operator to check the calibration accuracy of the scale after a specified number of weighments or weighing cycles. Scale accuracy can be checked by accessing **Home > Setup > Maintc > CalCkh**.

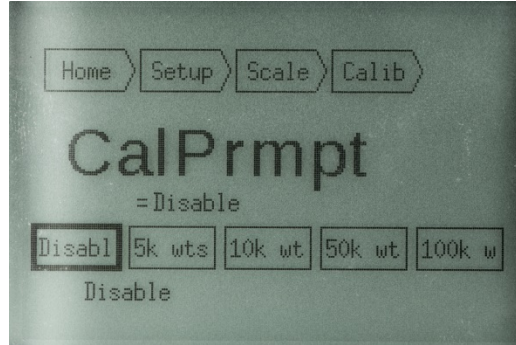

Figure 4-34: Calibration Prompt Screen

Options for this parameter are:

- Disabl
- 5K wts (5,000 weighing cycles)
- 10k wt
- 50k wt
- 100k w

Select the desired value and press ENTER to accept it. The **Calibration** screen will display.

4.11.6. Zero

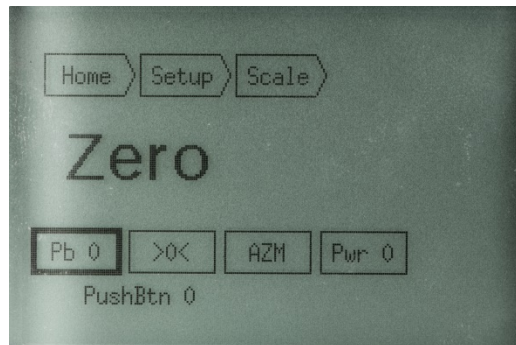

Figure 4-35: Zero Screen

The **Zero** screen allows the configuration of parameters that affect the way the scale zeroes. The options in this screen are:

- Pb 0** Pushbutton zero
- >0<** Zero Indicator – displays a center-of-zero icon on weighing display when the scale is zeroed

- AZM Automatic Zero Maintenance
- Pwr 0 Zero at power up

4.11.6.1. **Pushbutton Zero**

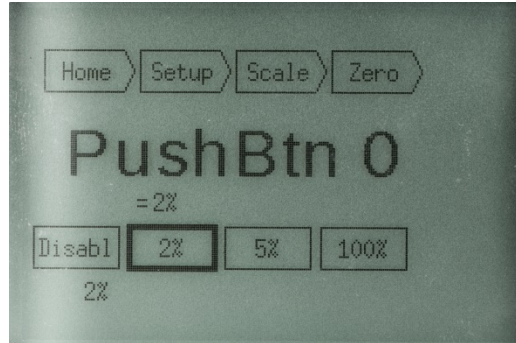

Figure 4-36: Pushbutton Zero Screen

When **Pb 0** is enabled, the Zero softkey **>0<** will appear on the weighing screen. Depending on the status of the scale and the setting selected in the **PushBtn 0** screen, the operator will be able to re-zero the scale by pressing the softkey.

The options are expressed as a percentage of the scale’s capacity, and determine how far from zero the scale can be before the pushbutton zero softkey won’t zero the scale. Options are:

- Disabl
- 2%
- 5%
- 100%

If **100%** is selected, the zero softkey will always zero the scale.

4.11.6.2. **Zero Indicator**

>0< can be set to **Disabl** or **Enable**. When it is enabled and the scale is stable within 0.25% of a division (the scale’s smallest increment size) of calibrated zero, an indicator will appear on the weighing screen at right, immediately below the weight display.

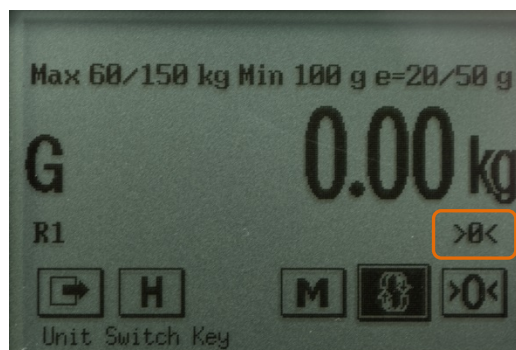

Figure 4-37: Center of Zero Indication

For example, on a scale with an increment size of 0.05 lb in normal rounding, debris on the platter weighing 0.0249 lb would still display a zero weight, and the center of zero icon will display whenever the debris weight is below 0.0125 lb.

4.11.6.3. Automatic Zero Maintenance

AZM can be set to **Disabl** or **Enable**. When it is enabled, and the weight indication on a scale is within a certain programmable band of zero but is not exactly at the center of zero, the scale will automatically track itself back to the center of zero.

AZM typically works in a range of 0.5 divisions (the smallest scale increment).

4.11.6.4. Power-Up Zero

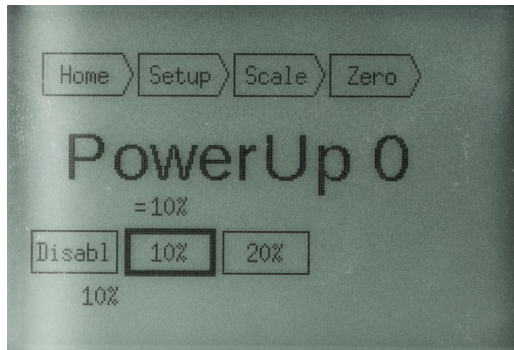

Figure 4-38: Power-Up Zero Screen

Pwr 0 sets the range, in percent of scale capacity, within which the scale will capture zero when it is first powered up. Options are:

- Disabl
 - 10%
 - 20%
- If Power-Up Zero does not capture zero, try re-booting the scale.

4.11.7. Rounding

This parameter sets the rounding method used by the scale. Normal rounding means that with a 0.05 lb increment, 0.0250 will round up to 0.05, and 0.0249 will round down to 0.00.

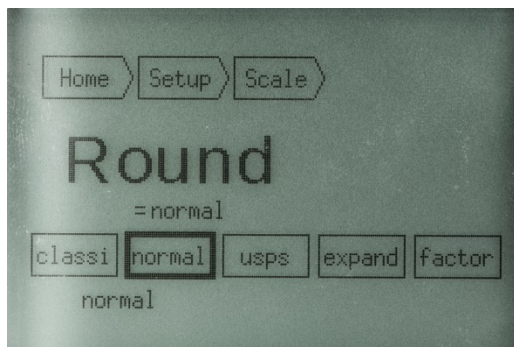

Figure 4-39: Rounding Screen

The options for this parameter are:

Classi Weight classifier rounding up; round up for values above zero (1+). Used for basic weighing only.

Normal Retail rounding: round up for values 5+.

Usps USPS rounding within maintenance tolerances. Used for basic weighing only.

Expand Displays expanded weight, typically at 10x resolution.

factor [For METTLER TOLEDO internal use only.]

■ Classifier and USPS rounding are used in basic weighing only.

■ Expanded weight displays the raw weight before rounding. It is not a legal rounding mode in the scale.

4.11.8. Functions

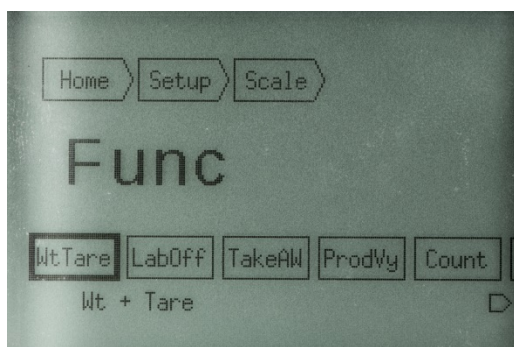

Figure 4-40: Functions Screen

The **Func** screen enables and disables weighing modes available to the operator. The set of modes available is protected by the metrology lock. Functions enabled here must also be selected in the **Home > OPMODE** screen in order to be available from the weighing screen.

Available functions are:

WtTare	LabOff	TakeAW	ProdVy
Count	Price	Hold	

These functions are described in detail in Chapter 3, Section 3.5.

Each function can be set to **disabl** or **enable**.

4.11.9. Boot-Up

The **Bootup dialog** screen is similar to a setup wizard, which prompts the operator for configuration on first power-up only. After first power up, the **Bootup** setting is disabled.

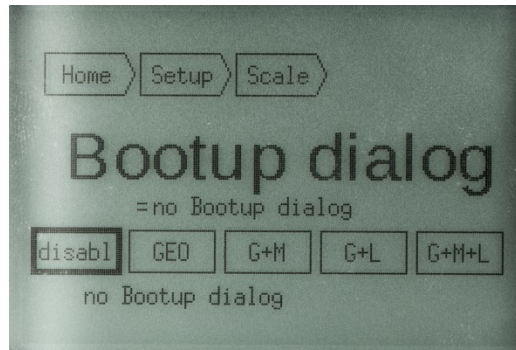

Figure 4-41: Bootup Dialog Screen

The options available in this screen are:

- disable** Disable the dialog.
- GEO** Prompt for GeoCal location code only.
- G+M** Prompt for GeoCal location code and Manifest Software with which the scale will communicate.
- G+L** Prompt for GeoCal location code and scale language and units.
- G+M+L** Prompt for GeoCal location code, scale language and units, and Manifest Software with which the scale will communicate.

Selections are described in detail in sections 4.11.9.1, 4.11.9.2 and 4.11.9.3. Once a selection is made in this screen and changes are saved at **Home > End > Save > [confirm]**, the selected dialog will display at next power-up. For example, if G+M+L is selected and the configuration saved, the next time the scale is powered up, the initial screen will be like the one shown in Figure 4-42.

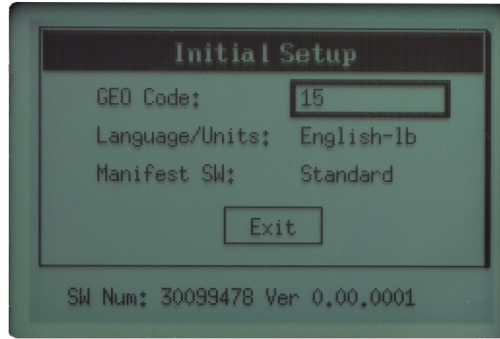

Figure 4-42: Boot Dialog, G+M+L

4.11.9.1. GeoCal

Use the LEFT and RIGHT arrows to select the correct value, from 00 to 31. Press ENTER to accept the selection.

For details about GeoCal, refer to section 2.2.4, Scale Configuration, in Chapter 2. This section also includes a table of locations and corresponding GEO codes.

- The METTLER TOLEDO GeoCal™ procedure uses the USEGEO parameter. Geo values can be viewed in the **Home > Info > Cal Info** screen.

4.11.9.2. Language and Units

Use the LEFT and RIGHT arrows to select the correct value. Options are:

- English – Lb
- English – Kg
- Spanish – Kg
- French – Kg
- German – Kg
- Chinese – Kg

4.11.9.3. Manifest Software

Use the LEFT and RIGHT arrows to select the serial communication defaults used to communicate with manifest software. Options are:

- Standard No change
- F ShipMGR FedEx Ship manager
- U Worldship UPS WorldShip
- D EasyShip DHL EasyShip
- P E-Ship Purolator E-Ship

4.11.9.4. Exit

Once the parameters are set, scroll to the EXIT softkey and press ENTER. The scale will continue the boot-up process.

4.12. Setup: Maintenance

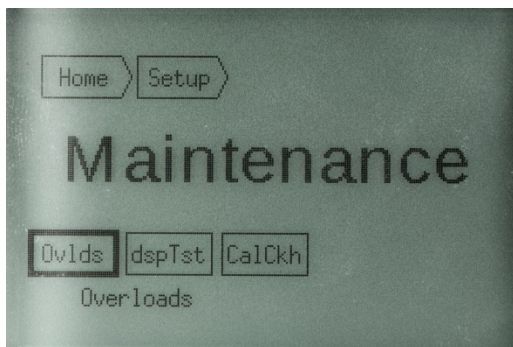

Figure 4-43: Maintenance Setup Screen

Scale tests can be run from the **Maintenance** screen, which also provides information about scale usage. Options are:

- OvlDs** Displays the number of times the scale has been over-loaded.
- dspTst** Runs a series of display test patterns to verify that all pixels are operating.
- CalCkh** Performs a calibration check for zero, and with a test weight.

4.12.1. Overloads

The scale tracks the number of times it has been overloaded. It keeps track of the date and time as long as power is applied to the scale.

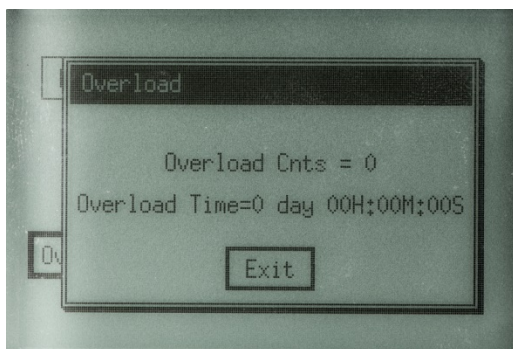

Figure 4-44: Scale Overloads Display

4.12.2. Display Test

The display test resembles the one that runs when the scale is powered up.

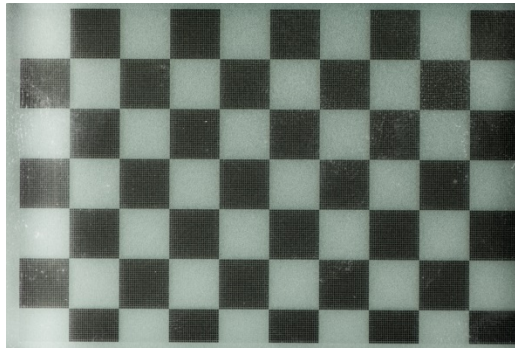

Figure 4-45: Example Display Test Screen

4.12.3. Calibration Check

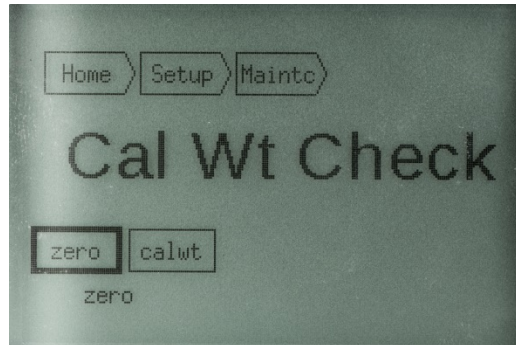

Figure 4-46: Calibration Check Screen

To perform the calibration check from this screen:

1. Check that the scale is level by looking at the level bubble.
2. For the zero test, clear the scale platter, scroll to the **zero** softkey and press ENTER. The scale will display a pop up window indicating that the test has completed successfully.

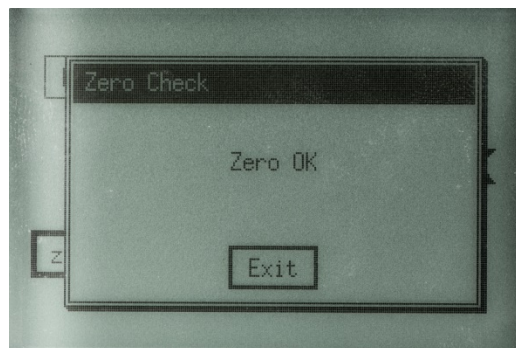

Figure 4-47: Zero Test Confirmation Screen

3. For the calibration weight test, place a test weight on the platter, scroll to the **calwt** softkey, and press ENTER. The scale will display the weight in expanded mode before rounding.

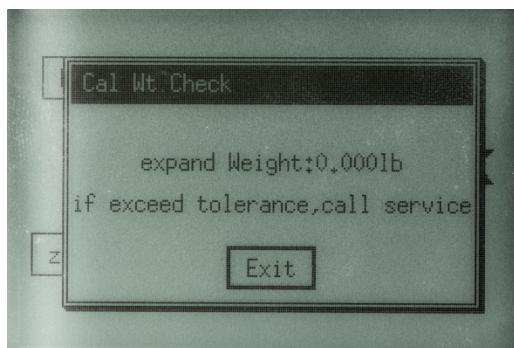

Figure 4-48: Calibration Weight Test Screen

4. If the test weight does not read the proper weight, check the tolerance allowed. The weight tolerance for Legal-for-Trade usage can be found via a web search for Handbook 44 (in North America) or R76 (for European and OIML approvals).

4.13. End

Before any changes (other than scale calibration) are saved, **Home > End** must be accessed, the settings saved, and the action confirmed.

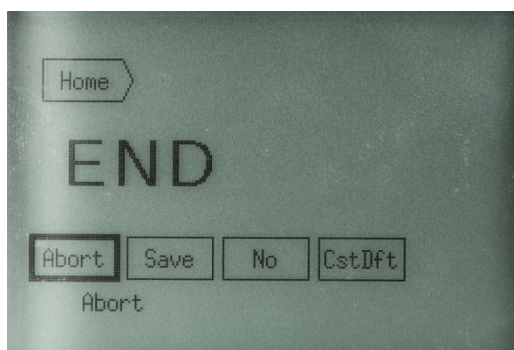

Figure 4-49: End Screen

The **End** screen offers the following options:

Abort After the selection is confirmed, the scale will reboot without saving setup changes.

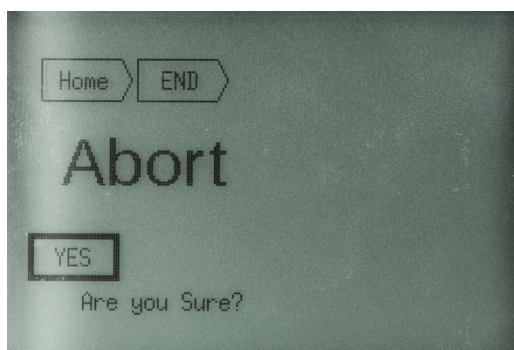

Figure 4-50: Abort Confirmation Screen

Save After the selection is confirmed, all changes will be saved and the scale will reboot.

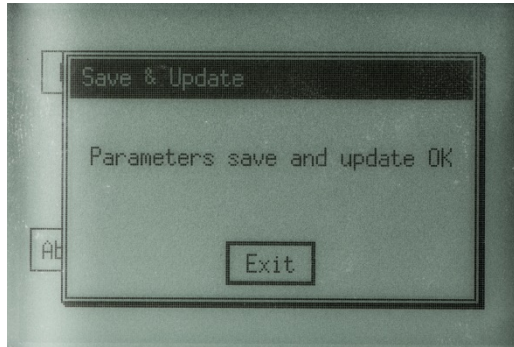

Figure 4-51: Save Confirmation Screen

No Returns to the Home page (Figure 4-1).

CstDft Saves current settings as a custom default for future reference. Default settings can be recalled at **Home > Defit > Custom**. When this option is selected, the scale will confirm the action and return to the End screen.

Note that at this stage, changes have not been saved.

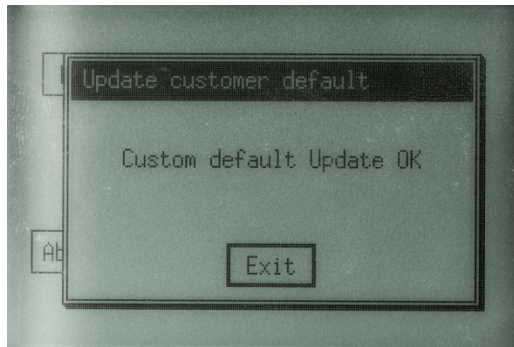

Figure 4-52 Custom Default Setting Confirmation Screen

4.14. Basic Display



Figure 4-53: Basic (7-Segment) Display

Although the 0270 Basic Display (seven-segment type) is typically used as a remote display, it can also be used as the scale's primary display. The scale functionality is greatly reduced in comparison to use of the graphical display. Basic weighing is the only operating mode when this

display is used. The limited setup parameters are accessed by pressing and holding the UNITS key for 5-8 seconds.

This display includes a **Unit Switch** key and a **Zero** key. All functionality is accessed using these buttons.

After entering Setup, the scale will display the Geo-Cal function on the first power up only if the parameter is enabled. Use the ZERO key to scroll through the selection of codes 00-31, and the UNITS key to accept the selection.

The other parameters that can be configured are:

GeoCal	Geo Code	Refer to the location and code table in Chapter 2.
CAL	Scale Calibration	When YES is selected, the scale will prompt for the zero capture, prompt for the selection of the Cal weight to be used, and complete the Span capture.
Mode (Node)	Rounding Method	Options are Classifier (Round Up), Normal rounding, USPS rounding, Expanded mode, and Factory mode. ■ Note that due to its graphical limitations, the 7-segment display shows N in place of M ; hence, Mode appears as Node .
Defaults	For serial communication	Use the ZERO key to scroll through the options; accept a selection by pressing UNITS key. Options are: No Change, Toledo, Def F1, Def F2, Def U, Def D, Def P, Toledo-OIML, MT-SICS, and Custom.
SAVE	Save parameters	All parameters are saved if YES is selected, and the scale will reboot. If NO is selected, settings are not saved and the scale returns to its basic weighing mode.

4.15. Metrological Sealing

If a wire seal is required for Weights and Measures approval, the BC scale can be sealed after calibration and setup by installing a wire seal on the Main PCB access cover,

BC-15 Single seal Loop the wire through the holding screw for PCB cover and holes in the plastic cover

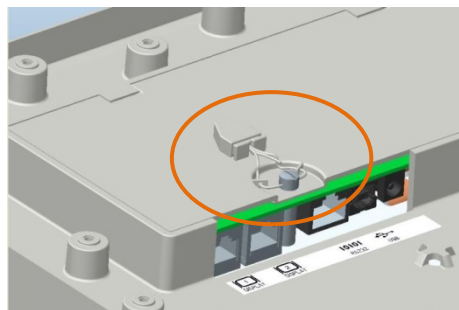

Figure 4-54: BC-15 Sealing

- BC-60 Two seals Loop the wires through:
- BC-6L
- BC-30
- BC-3L
1. The holding screw for the PCB cover on the bottom of the scale (left, in Figure 4-55).
 2. The green cap and tab hole on the housing scale (right, in Figure 4-55).

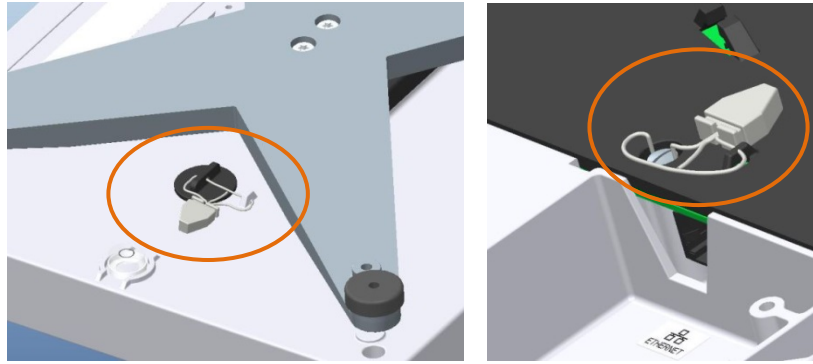

Figure 4-55: BC-60, -6L, -30 and -3L Sealing

- BC-150 Two seals
1. Loop the wire through the holding screw for the PCB cover on the bottom of the scale (left, in Figure 4-56).
 2. Loop the wire through the two drilled-head screws over the calibration switch (right, in Figure 4-56).

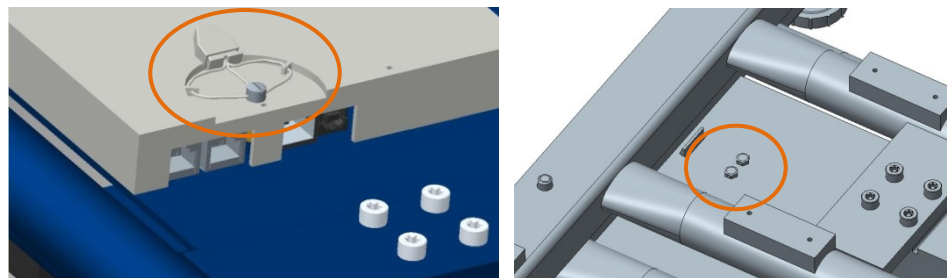

Figure 4-56: BC-15 Sealing

5 Service and Repair



This chapter covers

- Troubleshooting
- Update Scale Software
-

This chapter provides information on servicing, upgrading and maintaining the BC scale, including troubleshooting and replacement of key components.

5.1. Troubleshooting

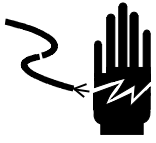
The BC shipping scale is designed to be virtually error-free and reliable. If problems do occur, do not attempt to repair the scale before you have determined the source of the problem. Record as much information as possible about what has happened including any messages and physical responses. The following troubleshooting information may help to determine the cause of the problem.

	 WARNING
	ALWAYS REMOVE ALL POWER BEFORE SERVICING ANY EQUIPMENT. METTLER-TOLEDO RECOMMENDS THAT ONLY QUALIFIED TECHNICIANS OPEN THE UNIT UP FOR MAINTENANCE AND REPAIR. IF YOU MUST OPEN THE BC SCALE, READ THIS SECTION CAREFULLY TO AVOID DAMAGE TO THE INTERNAL COMPONENTS.

5.1.1. Error Codes

The BC scale keeps a log of the five most recent errors. This information can be viewed by pressing the UP arrow for 5 seconds, then navigating to **Home > Info > Errors**.

When error codes are displayed on the weight indicator, they are shown with a leading **E** to distinguish them from weight data.

Table 5-1: Error Codes

Message Text	Action
New Approval selected, but SetDft not configured	Type Approval (HB44 / OIML) is interlocked with SetDft , the Default Build. Access Home > Setup > Scale > SetDft and select Yes . Parameters will be updated in setup, but not saved. Review the parameters in the remainder of setup. If they are acceptable, access Home > End > Save . If they are not acceptable, make the appropriate change or select Home > End > Abort and press Yes . Parameters will not be saved.
ERR_MENU_SEG_READ_LC_CAP = 0,	Wrong Build for scale model, Check if Load Cell cable is attached
ERR_MENU_SEG_CalibOrder,	Recalibrate
ERR_MENU_SEG_CALIBWT	Reconfigure weight
ERR_MENU_SEG_CLR_CALIB_PARAM	Recalibrate the scale, make sure there is no vibrations while calibrating
ERR_MENU_SEG_READ_SPAN_TOLERANCE	Error reading Test weight during calibration. Weight is out of tolerance range. Check setting of Cal Weight selected.
ERR_MENU_SEG_StoreParams,	Clear EEPROM. See SICS commands
ERR_MENU_SEG_GEO_SET	Error in setting the GEO CAL.. Reset and try again
Error Uart Framing	Serial Data Incorrect, check device and PC settings
Error Write EEPROM	Check if Load Cell cable is attached, Reload Firmware
OVERLOAD occur	Weight exceeded Scale capacity.

5.1.2. Check Power Adapter

- Contact METTLER TOLEDO for the correct power adapter part number. Using the wrong type of adapter may damage the scale.

The BC scale can have either of two power sources, depending on its mode of communication:

USB Does not require the power adapter. Scale is powered by PC.

RS232, Ethernet, Bluetooth* A power adapter is used with the USB cable to supply power to the scale.

* Ethernet and Bluetooth options not currently available.

To see if the scale is powered, check the display for activity, and/or look at the connectors under the scale. A green status light on the PCB behind the connectors should be lit or flickering, if the scale is receiving power.



Figure 5-1: Green PCB Status Light Illuminated

If the scale is not powered, use the following method to determine if there is a problem with the power adapter, the USB cable, or the scale:

1. Confirm that the AC outlet has power by plugging in another, functioning device.
2. Check the USB connections to the power adapter and the scale. Make sure the USB A connector is firmly attached to the power adapter and the USB B connector is firmly attached to the scale USB port. Plug the power adapter into the AC outlet.
3. If there is no power through the Power adapter, disconnect the serial cable, then disconnect the USB A connector from the power adapter and plug it into a USB port on the PC.
4. If there is still no power, try another USB cable that is known to be functional. Connect the new USB cable to the scale and PC.
5. If there is still no activity, consult a METTLER TOLEDO technician. The PCB may be damaged.

5.1.3. Blank Display

If the scale's display is blank:

- Check that the scale is receiving power, and that the display cable is attached to the scale base properly. Refer to section 5.1.2.
- Look at the connectors under the scale to see if the green PCB light is energized (Figure 5-1). If the scale is receiving power, the green light should be lit or flickering.
- For RS-232, confirm that the power adapter is plugged into a working AC outlet and the USB cable is properly plugged into the power adapter and scale.
- For USB, make sure the USB cable is pushed in all the way at both the scale and the PC.

Once it is verified that the scale is receiving power, and the display remains blank, check the display cable at the connectors. Unplug the display by pushing in on the connector tab and pulling back on the cable. Reinsert the display cable into the scale connector, making sure the tab clicks into position.

If the display still does not work, connect the display to the secondary display connector.

If the display is still blank, it must be replaced.

5.1.4. No Keypad Interaction

To test the operation of the keypad, remove power from the scale, then reapply it. With the unit powered, allow the scale to go through its boot-up sequence, and then attempt to enter setup mode by pressing and holding the UP key for 5 to 8 seconds. If the display does not display the **Home** page, replace the display.

5.1.5. Display Indicator Locked

A display test can be run to check the functionality of display pixels. This is the same test shown at boot-up. Access **Home > Setup > Maintc**. Select **dspTst** and press ENTER. A series of test patterns will display.

To test operation of the display indicator, remove power and then reapply it. With the unit powered and display reading zero, add weight. If the displayed weight does not change, check the cable connection from the load cell to the PCB. Disconnect and reconnect the cable. Refer to section 5.4, **Load Cell Replacement**.

If the display appears to function but will not indicate a weight, replace either the load cell or the PCB.

5.1.6. Serial Communication Test with PC

■ This test does not apply if PC communication is via USB.

A HyperTerminal serial (RS-232) test can be conducted to see if serial communication problems are occurring. This test can determine if the issue is with the scale connection / communication to the PC, or if the issue is within the shipping software program itself.

■ Note: HyperTerminal is no longer standard in Win 7 or later versions of Windows. It can still be obtained on-line or copied from an XP computer. Similar Programs such as PuTTY or MT Albatross can also be used.

The HyperTerminal test will confirm

- If the scale is properly connected to the PC
- If the scale is able to communicate by serial RS232 to the PC
- If the scale is able to display the correct weight

Run this test whenever it is unknown why the manifest or shipping software is not showing a weight, or the proper weight, on the PC screen.

1. Connect the scale to the PC as shown in Figure 5-2. Note the COM port on the PC that the scale is connected to; this information will be needed in step 5

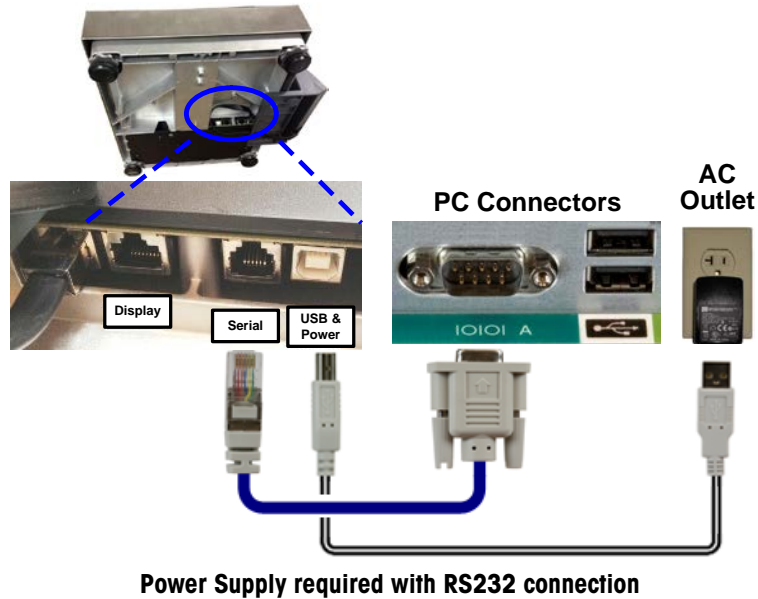

Figure 5-2: Serial Connections

2. After the scale powers up, enter the GeoCal value if **Geo in** is displayed. Refer to Chapter 3 for Geo Location Codes, and how to enter the value.
3. Check the scale's serial set up parameters at **Home > SetUp > Comm > Serial**. Write down the values for Baud, ASCII, Parity, Stop Bits and Protocol; they will be needed to enter the matching data in the HyperTerminal screen.
4. Access the HyperTerminal program on your PC as shown in Figure 5-3 (the way to run a program differs between different Windows operating systems). HyperTerminal is a standard Windows program in XP operating systems under **Accessories > Communications**, and can still be downloaded from the Internet for later versions of Windows. An Internet search for HyperTerminal will show numerous suppliers.

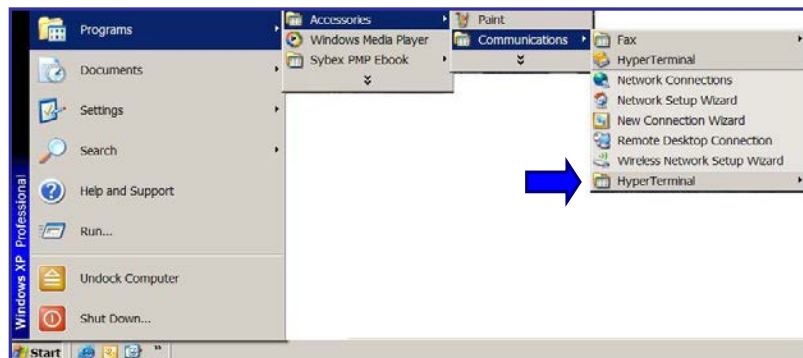
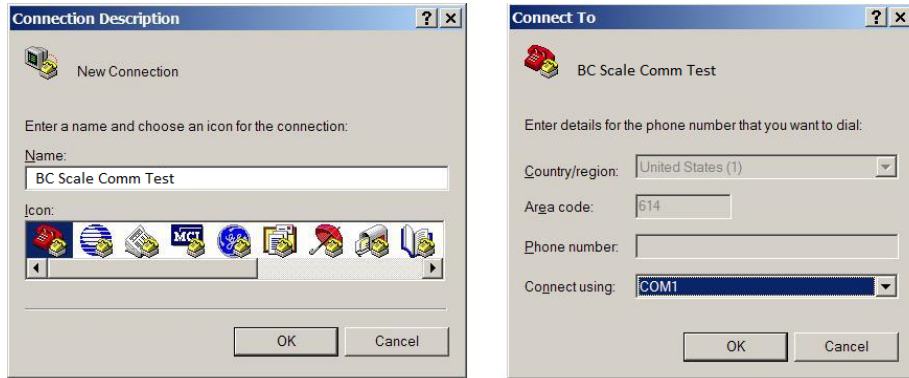

Figure 5-3: Opening Hyperterminal

5. Once HyperTerminal is opened, choose **File | New Connection**. Name the connection **BC Scale** for future reference and click **OK**. Click on the drop-down bar for **Connect Using**. Select the

communication port that the scale cable connects to on the PC. COM A is equivalent to COM 1. Click **OK** when completed.



6. Program the same setup parameters in HyperTerminal as used in the scale (Baud = Bits per second). For the **Flow Control** setting, select **None** – the scale does not use this parameter.

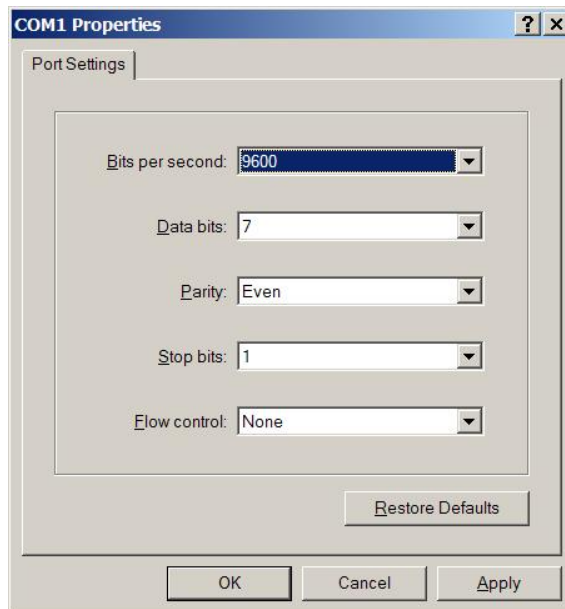

7. Click **Apply** after entering the values. The data will be accepted. Click **OK**, and a blank HyperTerminal screen will appear.
8. Now that the scale set up matches the HyperTerminal set up, put some weight on the scale and note the displayed value.
9. Go to the HyperTerminal screen and click on the blank screen.
10. Enter the weight command that corresponds to the scale’s protocol setting (**Home > Setup > COMM > Serial > Protoc**).

Weight Protocol	Proto	Enter
METTLER TOLEDO	Toledo	W
FedEx	Proto F	W <CR>
UPS	Proto U	<CR>

Weight Protocol	Proto	Enter
Purolator	Proto P	W <CR>
DHL	Proto D	W <CR>
MT SICS	MT-SIC	S <CR>

- <CR> is carriage return, or ENTER.
- Uppercase letters must be used.
- The typed character will not display unless Echo is checked in HyperTerminal's settings – in HyperTerminal, access **File | Properties | Setting | ASCII Setup**, and click **Echo typed characters locally**. If the MT-SICS is used, also check **Send line ends with line feeds**.

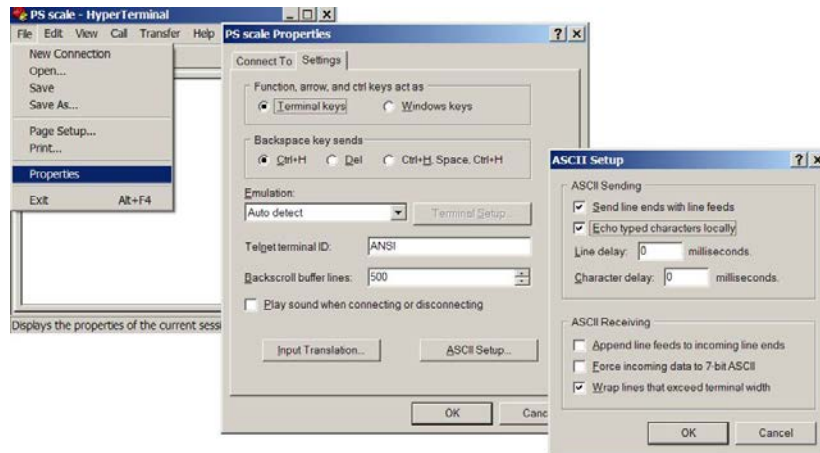
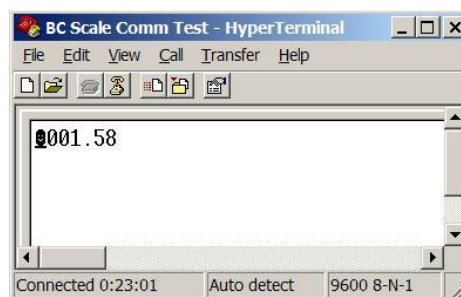

Figure 5-4: HyperTerminal ASCII Settings

11. A weight value should now be displayed on the HyperTerminal screen that matches the weight on the scale display. If another message appears, zero the scale first by repeating this step with no weight, then try again with a weight.



12. If the same weight is displayed on the scale and HyperTerminal screen, the scale is communicating correctly to the PC.

Consult the Shipping Software provider for further assistance.

- Note: Exit HyperTerminal before trying to communicate to the manifest software again.

5.2. Update Scale Software

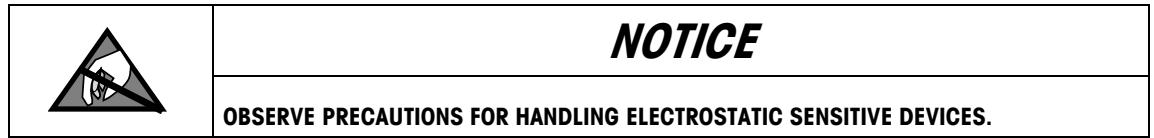

Ensure that current settings are saved by backing them up for future reference.

The BC scale software can be updated without any hardware changes. Simple Loader is a METTLER TOLEDO application used to load the new software into the scale. The application can be downloaded from the METTLER TOLEDO website at www.mt.com/ind-BCscale. Click on the **Download** tab, select **Simple Loader**, and download to a local PC folder.

- This procedure requires a serial connection. An external USB-to-Serial adapter (such as Keyspan USA-19HS) can be used if the PC does not have a serial connection to the scale. The scale's virtual serial setting will not function for this purpose, since it uses the USB port. Use cable [16317400A/64052046](#).

Please reference the operating instructions ([Simple Loader Operating Instructions.pdf](#)) additional details are needed:

Check which PC COM port the scale is connected to.

On the PC, go to **Start > Control Panel > Device Manager**. Click on **Ports** and select the proper COM port. Make sure no other serial program is using the same port as the scale. Shut down HyperTerminal or any other serial tool before starting the firmware update.

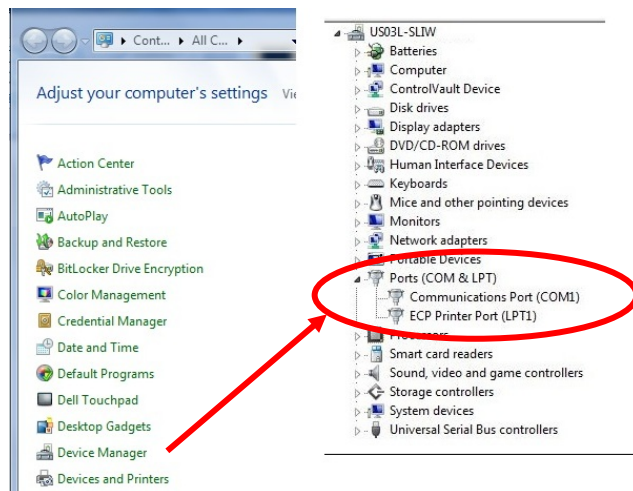

Figure 5-5: Device Manager, Port Settings

Simple Loader program is based on the SICS protocol, but the scale will upload the firmware regardless of what Protocol the scale is set for. If the SICS protocol is not used, an error message 107 will appear. This message can be ignored if the scale is not set up for SICS.

- For an upload that does not encounter Error 107, set the scale protocol to MT-SICS. This can be done by pressing and holding the UP key for 5 seconds to enter setup, then accessing Home > Defaults, highlighting MT. Access Home > Defit, highlight SICS and press ENTER. Access to Home > End > Save and save the settings.

Open the PC file for the SimpleLoader by double clicking on the icon.



Figure 5-6: SimpleLoader Icon

With SimpleLoader open, click on the **Settings** tab in the toolbar, then click on **General Settings** in the drop down list. Update the COM port if needed, and set **Baud rate** to 57600 or 115200. Click the **Change...** button in the bottom portion of the box, and browse to the location of the scale .mot file. Highlight the file and click **Open**. The file is now selected.

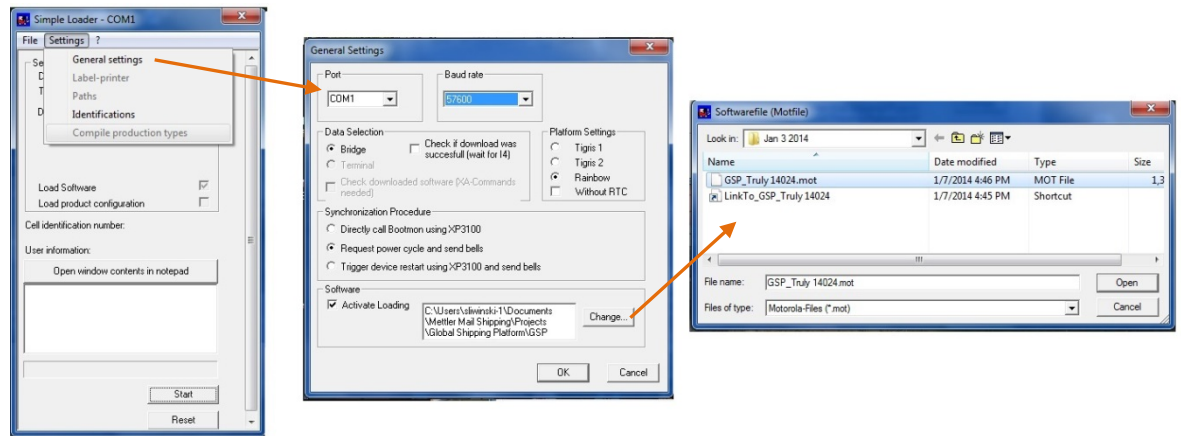

Figure 5-7: Configuring SimpleLoader

If necessary, select radio buttons for **Bridge**, **Rainbow**, and **Request power cycle and send bells**. Check **Activate Loading** and click **OK**.

When ready for the update, press **Start** (at left, in Figure 5-7) and immediately reboot the scale. The scale software will start to load into the scale, and progress will be indicated by a blue bar (Figure 5-8). The download time may be several minutes.

- Once the process is started, the system must be rebooted quickly – within 3 seconds. The procedure is to click Start, immediately unplug the scale’s power adapter, then plug it back in to reboot the scale.

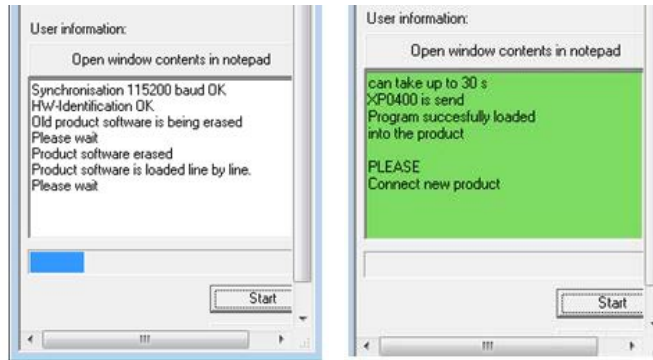

Figure 5-8: SimpleLoader Running (left) and Download Complete (right)

When the download is complete, the screen will state **Program successfully loaded into the product**.

- If an error 101 Timeout error is shown, the scale was not rebooted in time. Initialize the process again. An error 107 can be ignored.

5.3. Main PCB Replacement

To replace the PCB:

1. Record the scale's setup configuration. Refer to the setup menu trees in section 4.3 of Chapter 4 – a printed copy of these can be used to note current settings.
2. Remove power from the scale and remove the platter.
3. Use an appropriate wrist wire or other means to ensure static grounding.
4. Turn the scale upside down.
5. Disconnect the scale display cable, communication cable (USB/RS-232), and power adapter cable (if used) from the scale connectors.

6. Remove the PCB cover, shown outlined in Figure 5-9. If there is a metrology lock seal, it must be broken. Note the scale connectors that are attached to the PCB.

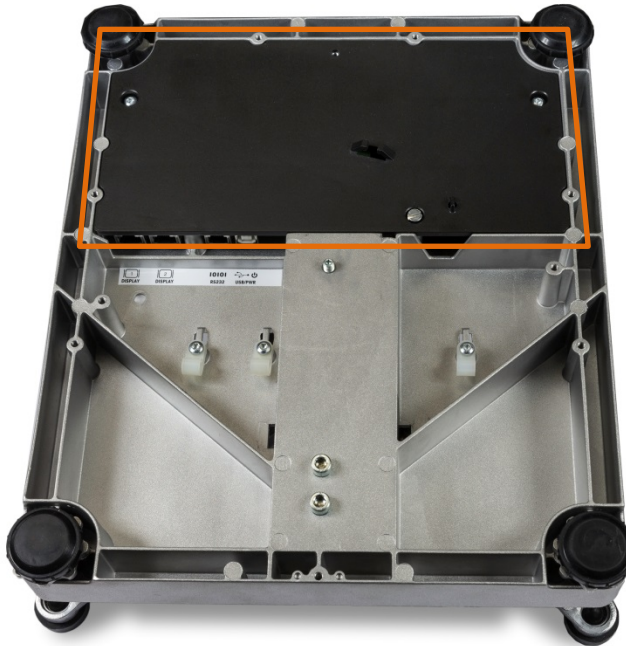

Figure 5-9: PCB Cover In Place

- BC-15** Remove the slotted screw, lift the front edge of the PCB cover and pull it free from the rear base tabs.
- BC-60, 6L, 30 and 3L** Remove the base display by unscrewing the three T20 Torx screws. Remove the PCB cover by removing the slotted screw and the two T20 Torx screws. Lift off the cover.
- BC-150** Remove the slotted screw. Release the snap tab next to the connector opening and lift the cover assembly from the scale frame. The PCB is attached to the cover.

7. Remove the PCB.

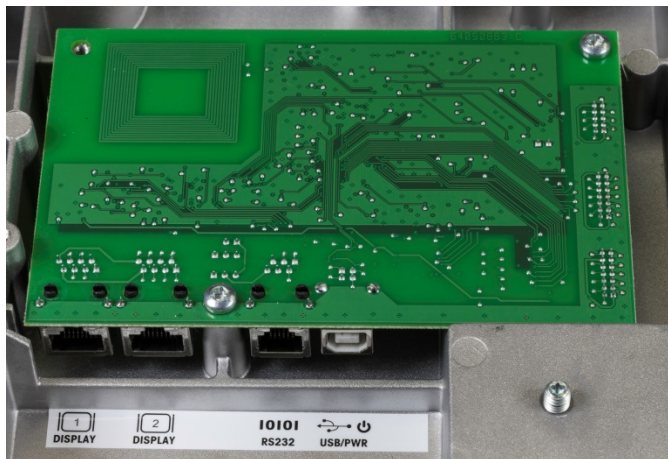

Figure 5-10: BC Scale PCB Mounting – Example

- BC-15** Remove the two T20 Torx screws and lift the PCB out.
- BC-60, 6L, 30 and 3L** Remove the two T20 Torx screws and lift the PCB out of the cover.
- BC-150** Release the snap tabs near the rear of the PCB and lift it out of the cover.

8. Disconnect the load cell harness. Carefully slide the tabs on either side of the connector away from the connector body. Slide out the load cell harness.



Figure 5-11: Load Cell Harness Connected to PCB

9. Connect the load cell harness to the new PCB.
10. Install the new PCB using the fasteners removed in step 7. Hold the PCB's edges to keep the board square as it is being secured.
11. Reconnect the display cable and communication cable (USB or RS-232) to the scale connector ports.
12. Reinstall PCB cover using the fasteners removed in step 6, and power up scale.
13. Press and hold the UP arrow to access setup. Enter required setup parameters and calibrate the scale, as described in Chapter 4, section 4.11.5.

5.4. Load Cell Replacement

When replacing a load cell, please be sure to use the correct part number to match the capacity shown on the scale's data label, or at **Home > Info > Model**. (Press the UP arrow for 5 seconds to access the Home screen.) In case of uncertainty, contact METTLER TOLEDO Technical Service for the correct part number to order.

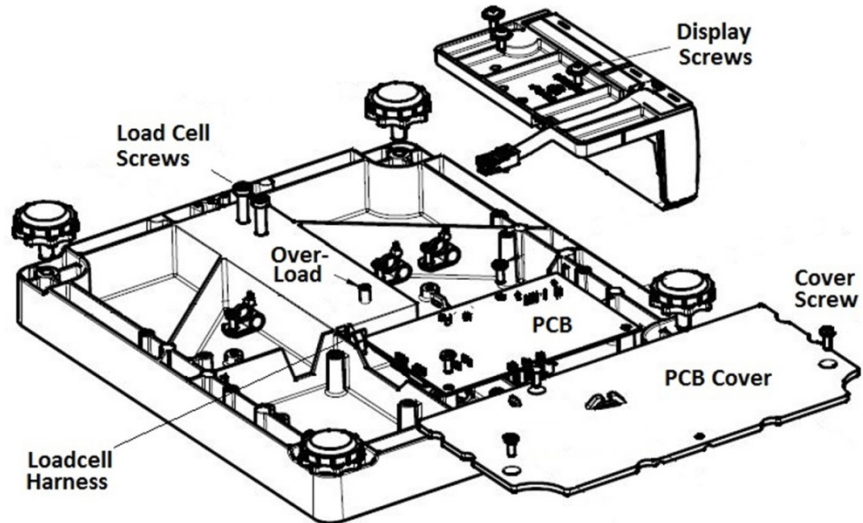

Figure 5-12: Bottom View of Scale

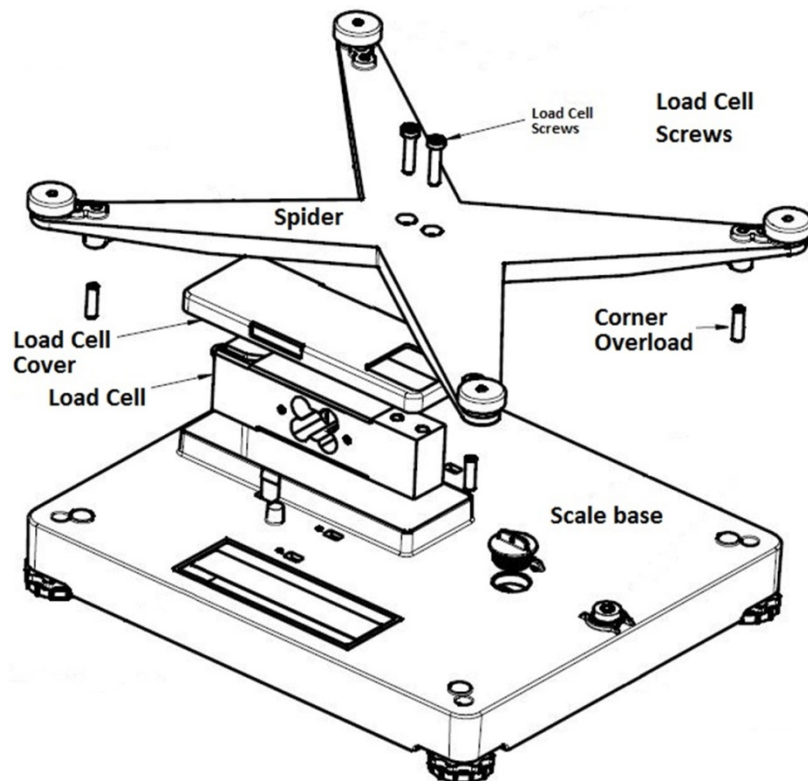

Figure 5-13: Top View of Scale

To change out the load cell refer to Figure 5-12 and Figure 5-13, and follow these steps:

1. Remove power from the scale and remove platter.
2. Make sure you are statically grounded with appropriate wrist wire or other means.
3. Remove the scale sub-platter (spider) from the load cell.

BC-15	Remove the two T30 Torx screws and lift off the sub-platter.
BC-60, 6L, 30 and 3L	Remove the two T30 Torx screws and lift off the sub-platter.
BC-150	Remove the four T30 Torx screws and lift off the sub-platter frame.
4. Remove load cell cover (BC-60, -6L, -30, & -3L only). Use a small flat blade screw driver to release the cover from the retention tabs (one on each side) on the scale base.
5. Remove the PCB cover (Figure 5-9). If there is a metrology lock seal, it must be broken. Note the scale connector attached to the PCB.

BC-15	Remove the slotted screw, lift the front edge of the PCB cover and pull it free from the rear base tabs.
BC-60, 6L, 30 and 3L	Remove the base display by unscrewing the three T20 Torx screws. Remove the PCB cover by removing the slotted screw and the two T20 Torx screws. Lift off the cover.
BC-150	Remove the slotted screw. Release the snap tab next to the connector opening and lift the cover assembly from the scale frame. The PCB is attached to the cover.
6. Unbolt the PCB from the base with T20 Torx. Lift the PCB carefully and flip over to access the load cell connector.
7. Disconnect the load cell harness from the PCB (Figure 5-11).

BC-15, BC-60, 6L, 30 and 3L	Carefully pull up white tabs on each side of connector and pull ribbon harness out.
BC-150	Pull up on white tabs of harness connector.
8. Remove the bottom load cell bolts, flip the scale over, and remove load cell from the scale base.

BC-15	Use a T30 Torx (6 mm hex wrench) to remove the two bolts on bottom of base by the load cell harness.
BC-60, 6L, 30 and 3L	
BC-150	Remove the four T30 Torx screws and lift out the load cell.
9. Install new load cell using the fasteners removed in step 8. Orient load cell so harness is in its proper position to attach to its connector.

BC-15	Use a T30 Torx (6 mm hex wrench) to tighten the screws to 85 in.lbs / 9.9 N-m torque.
BC-60, 6L, 30 and 3L	
BC-150	Use a T30 Torx (6mm hex wrench) to tighten the screws to 85 in.lbs / 9.9 N-m torque.

10. Connect the load cell harness to the PCB.
11. Attach the PCB to the scale housing using the fasteners removed in step 6.
12. Attach the load cell cover using the fasteners removed in step 5. Push until the plastic cover clips into place. Make sure the load cell cover does not touch the load cell.
13. Attach the spider to the load cell using the fasteners removed in step 3. Make sure load cell cover does not touch the spider.

BC-15	Use a T30 Torx (6 mm hex wrench) to tighten the screws to 85 in.lbs / 9.9 N-m torque.
BC-60, 6L, 30 and 3L	Slide the load cell harness through the housing towards the PCB. Use a T30 Torx (6 mm hex wrench) to tighten the screws to 85 in.lbs / 9.9 N-m torque.
BC-150	Use a T30 Torx (6 mm hex wrench) to tighten the screws to 85 in.lbs / 9.9 N-m torque.
14. Set overload protection by adjusting the overload screws at each corner:
 - a. Turn the platter over and place it on top of scale so the corner overload screws can be seen.
 - b. Place a full-capacity weight on the scale and check for clearance at each corner overload.
 - c. Use a feeler gauge to check that the gap is set at 0.010" (0.254 mm) +/- 0.003" (0.076 mm).
15. Turn the platter over and place it on the scale. Power up the scale by attaching the USB cable to a PC or the power adapter.
16. Calibrate the scale as described in Chapter 4, section 4.11.5.
17. Check that maximum capacity is seen on the scale. If scale does not read up to its maximum capacity (e.g., weight only goes to 54 kg on a 60 kg capacity scale), then adjust the overloads.
 - Note: There may be up to 5 overloads – four corner overloads and one under the scale load cell.
18. If required, add metrology seal/s per local regulations. Refer to Chapter 4, section 4.15.

5.5. Base-Mounted Display Replacement

The model number for a base-mounted graphical display unit is 0271-1100-000 (30111587).

To replace the base mount display:

1. Disconnect the cable from the scale display socket on the bottom of the scale by pushing in the tab and gently pulling the cable.



Figure 5-14: Display Connector Sockets

2. Remove the existing display bracket from the scale by loosening the display bolts.



Figure 5-15: Display Mounting Bolts and Cable

BC-15

Three T20 Torx (M4 10 mm) screws

BC-60, 6L, 30 and 3L

BC-150

Three T20 Torx . The BC-150 is equipped with a long cable since a high percentage of BC-150 installations have the display mounted remotely, rather than base-mounted. If the scale has a base-mounted display unit, the standard model 0270-1100-000 is an acceptable replacement and the long cable is not needed.

3. Pull the display cable out from the slot in the bracket.
4. Thread the end of the display cable through the slot at the back of the new mounting bracket, then attach the new display unit to the bottom of the scale using the fasteners removed in step 2.
5. Attach display cable to one of the connector sockets labeled **Display** (Figure 5-14).

A Serial (RS-232) Host Interface

This appendix covers

- Communication Parameters
- Protocols
- Scale Status Byte Information
- Scale Confidence Byte Information
- Calibration Using Host Interface

The METTLER TOLEDO BC shipping scale can function as a peripheral device to a host computer. In host mode you can:

Calibrate the scale (Toledo Proto setting only)

Request and receive weight data when the scale is in a stable state

Request and receive the scale's status when the scale is in an unstable or invalid state

Zero the scale and/or switch units (depending on setup)

This Appendix presents information and instructions on how to use the BC in host mode.

- The scale does not reply to host weight commands if it is in calibration mode or if the scale cannot capture zero on power-up

A.1. Communication Parameters

Data is transmitted and received by the scale through an RS-232 serial port connection. The following communication parameters are supported:

- Baud Rate (1200, 2400, 4800, 9600, 19200, 38400, 57500)
- Parity (none, even, odd, mark, space)
- ASCII bit string (7 or 8)
- Stop bits (1, 2)

The scale only responds to commands, unless Send Weight is activated, Keypad, stable weight, or continuous data output is available.

A.2. Protocols

The scale can be programmed to respond to a selected "menu" of defined protocols. The host sends requests to the scale in the form of ASCII data and control characters as determined by the selected protocol. The scale responds to the host with a string of ASCII characters. ASCII characters and their binary conversions are listed in the following table:

A.2.1. ASCII Characters and Conversions

ASCII CHAR.	DEC	HEX	76543210
NULL	0	00	00000000
SOH	1	01	00000001
STX	2	02	00000010
ETX	3	03	00000011
EOT	4	04	00000100
ENQ	5	05	00000101
ACK	6	06	00000110
BELL	7	07	00000111
Backspace	8	08	00001000
TAB	9	09	00001001
Line Feed	10	0A	00001010
Vert. Tab	11	0B	00001011
Form Feed	12	0C	00001100
Carr. Return	13	0D	00001101
Shift Out	14	0E	00001110
Shift In	15	0F	00001111
Data Link Esc	16	10	00010000
DC1	17	11	00010001
DC2	18	12	00010010
DC3	19	13	00010011
DC4	20	14	00010100
NAK	21	15	00010101
SYNCH IDLE	22	16	00010110
End Trans.	23	17	00010111
CANCEL	24	18	00011000
End Of Medium	25	19	00011001
Substitute	26	1A	00011010
ESCAPE	27	1B	00011011
FS (Cur. Right)	28	1C	00011100
GS (Cur. Left)	29	1D	00011101
RS (Cursor Up)	30	1E	00011110
US (Cur. Down)	31	1F	00011111
@	64	40	01000000
A	65	41	01000001
B	66	42	01000010

ASCII CHAR.	DEC	HEX	76543210
SPACE	32	20	00100000
!	33	21	00100001
"	34	22	00100010
#	35	23	00100011
\$	36	24	00100100
%	37	25	00100101
&	38	26	00100110
'	39	27	00100111
(40	28	00101000
)	41	29	00101001
*	42	2A	00101010
+	43	2B	00101011
,	44	2C	00101100
-	45	2D	00101101
.	46	2E	00101110
/	47	2F	00101111
0	48	30	00110000
1	49	31	00110001
2	50	32	00110010
3	51	33	00110011
4	52	34	00110100
5	53	35	00110101
6	54	36	00110110
7	55	37	00110111
8	56	38	00111000
9	57	39	00111001
:	58	3A	00111010
;	59	3B	00111011
<	60	3C	00111100
=	61	3D	00111101
>	62	3E	00111110
?	63	3F	00111111
`	96	60	01100000
a	97	61	01100001
b	98	62	01100010

ASCII CHAR.	DEC	HEX	76543210
C	67	43	01000011
D	68	44	01000100
E	69	45	01000101
F	70	46	01000110
G	71	47	01000111
H	72	48	01001000
I	73	49	01001001
J	74	4A	01001010
K	75	4B	01001011
L	76	4C	01001100
M	77	4D	01001101
N	78	4E	01001110
O	79	4F	01001111
P	80	50	01010000
Q	81	51	01010001
R	82	52	01010010
S	83	53	01010011
T	84	54	01010100
U	85	55	01010101
V	86	56	01010110
W	87	57	01010111
X	88	58	01011000
Y	89	59	01011001
Z	90	5A	01011010
[91	5B	01011011
\	92	5C	01011100
]	93	5D	01011101
^	94	5E	01011110
_	95	5F	01011111

ASCII CHAR.	DEC	HEX	76543210
c	99	63	01100011
d	100	64	01100100
e	101	65	01100101
f	102	66	01100110
g	103	67	01100111
h	104	68	01101000
i	105	69	01101001
j	106	6A	01101010
k	107	6B	01101011
l	108	6C	01101100
m	109	6D	01101101
n	110	6E	01101110
o	111	6F	01101111
p	112	70	01110000
q	113	71	01110001
r	114	72	01110010
s	115	73	01110011
t	116	74	01110100
u	117	75	01110101
v	118	76	01110110
w	119	77	01110111
x	120	78	01111000
y	121	79	01111001
z	122	7A	01111010
{	123	7B	01111011
	124	7C	01111100
}	125	7D	01111101
~	126	7E	01111110
	127	7F	01111111

A.2.2. Toledo Protocol Host Commands

Table A-1 provides a list of host commands and scale responses. Brackets "< >" are used to indicate that the characters within are a description of the transmitted data and are not part of the transmitted data string. <STX> indicates an ASCII Start-of-Text character (HEX 02). <CR> indicates an ASCII Carriage Return (HEX 0D).

Table A-1: Host Commands

Command	Command Description	Scale Response
'W'	Send normal resolution weight data	<STX>XXXlbXX.Xoz<CR> (for lb-oz build) <STX>XXlbXX.XXoz<CR> (for lb-oz build - HR) <STX>XXXXXX<CR> (for lb. kg and gram build) <STX>?<StatusByte><CR> (if current weight is negative, over zero, over capacity, motion..)
	Weight and tare, Label Offset Send normal resolution weight in lbs Send normal resolution weight in lbs NET Send normal resolution weight in kgs Send normal resolution weight in kgs NET (Weight out of range or in motion) Net weight Add the symbol "-" or, if positive value, use sp	<stx>XXXXXXG<sp/minus>XXXXXXlbN?<status-byte><cr> <stx>XXXXXXG<sp/minus>XXXXXXkgN?<status-byte><cr> <stx>XXXXXXG<sp/minus>XXXXXX<sp>gN?<status-byte><cr> <stx>...lb...ozG<sp/minus>...lb...ozN?<status-byte><cr> (...lb...oz is 11-byte string)
'H'	Send x10 expand weight data	<STX>XXXXXX<CR> (for lb-oz build, weight is reported in oz) <STX>XXXXXX<CR> (lb., kg, gram build) <STX>?<StatusByte><CR>(if current weight is negative, over zero, over capacity, motion..)
'A'	Perform a confidence test of RAM, ROM and EEPROM. Store results of tests in confidence status byte for later retrieval.	<STX><CR> The scale responds with <STX><CR> indicating the command was received
'B'	Send results of confidence test	<STX>?<Confidence Status byte><CR> Confidence test status byte
'C'	Initiate host interface scale calibration	Refer to Section A.1.3 for detailed description
'D'	Differential Weights (Take away, Prod verification Modes) G=Gross, N= Net, D= differential wt (x10)	<stx>XXX.XXG<sp>XXX.XXN<sp>XXX.XXX<kg/lb/<sp>g>D?<status-byte><cr> <stx>...lb...ozG<SP>...lb...ozN<sp>...lb...ozD?<statusbyte><cr> > Note: ...lb...oz is 11-byte string, ...lb....oz is 12-byte string for x10 expand weight Note: Differential Weight is always reported as Absolute Value = +Positive value only

A.3. Scale Status Byte Information

When communicating in host mode using the standard Toledo protocol, the BC may send status bytes containing information such as motion and over/under-capacity conditions. The message <STX>?<status byte><CR> indicates transmission of a status byte. The status byte sent is an ASCII character that must be converted to binary form for decoding the bits. The ASCII character table with binary conversion (given in the previous section) can be used to convert status bytes. The bits of the status byte in the standard Toledo protocol are defined in Table A-2.

Table A-2: Status Bytes

Bit No.	Bit Description
6	1 = Avoir 0 = Metric
5	1 = No tare was taken 0 = Tare was taken.
4	1 = Center of zero 0 = Not at center of zero
3	1 = Outside zero capture range 0 = Within range
2	1 = Under zero 0 = Within weighing range
1	1 = Over capacity 0 = Within weighing range
0	1 = Scale in motion 0 = Stable weight data

A.4. Scale Confidence Byte Format

When communicating in host mode using the standard Toledo protocol, the host may ask the BC to store and send confidence bytes containing information about RAM, ROM, and EEPROM testing. The message <STX>?<confidence byte><CR> indicates transmission of a confidence byte. The confidence byte sent is an ASCII character that must be converted to binary form for decoding the bits. The ASCII character table with binary conversion (given in section A.3) can be used to convert status bytes. The bits of the confidence byte in the standard Toledo protocol are defined in Table A-3.

Table A-3: Confidence Bytes

Bit No.	Bit Description
6	1 = New status data available. 0 = Host has read data.
5	Bit is always a 0.
4	1 = ROM test failed. 0 = ROM test passed.

Bit No.	Bit Description
3	1 = RAM test failed. 0 = RAM test passed.
2	Bit is always a 0.
1	1 = Calibration Required. 0 = Calibration Data OK
0	1 = EEPROM test failed 0 = EEPROM test passed.

A.5. Calibrate Using Host Interface

The BC shipping scale can be calibrated using the host interface. The command to initiate the calibration sequence is available in the METTLER TOLEDO command set. Calibration is based on the current scale configuration for units and capacity/increment. These can be changed (through the keypad or the host interface) before calibrating the scale through the host interface.

To calibrate using the host interface:

1. Remove the platter, break the legal-for-trade seal (if present) on the green cap, and remove the green cap to give access to the PCB.
2. Press the Cal button SW-2. Refer to the calibration diagram in Chapter 4 of this manual. DO NOT ENTER SETUP MODE. The BC does not respond to host commands in calibration mode.
3. Send the command **C** to initiate calibration sequence. The scale responds
4. `<STX>CALIBRATE?<CR><LF>`.
5. Send the command **Y** to continue with the calibration sequence, or send the command **N** to abort the sequence. The scale responds `<STX>UNLOAD SCALE- Y?<CR><LF>`.
6. Remove any weight on the platter and send the command **Y** to continue. A stable zero reading is taken, then the scale responds
7. `<STX> ADD (Weight Value) (Weight Units) Y? <CR><LF>` , where
 (Weight Value) = weight amount (two or three digit number) to add to scale
 (Weight Unit) = LB or KG
8. Add the requested calibration weight to the scale, and then send the command **Y** to continue. The scale responds
`<STX> CAL DONE <CR><LF>`
 or
`<STX> INCORRECT AMOUNT OF WEIGHT <CR><LF>`.

B USB Host Interface

This appendix covers

- References
- Hardware
- Electrical Connection
- Power
- Protocol

The USB 2.0 interface on this scale is used in applications where a USB interface, which conforms to the Microsoft™ USB HID Point-Of-Sale, is required.

B.1. References

The following documents can be found on the official USB Web page.

Universal Serial Bus Specifications, Revision 2.0:

<http://www.usb.org/developers/docs/>

Universal Serial Bus Device Class Definition for Human Interface Devices (HID), Version 1.11:

http://www.usb.org/developers/devclass_docs/HID1_11.pdf

Universal Serial Bus HID Usage tables, Version 1.12:

http://www.usb.org/developers/devclass_docs/Hut1_12.pdf

Universal Serial Bus HID Point of Sale Usage Tables, Version 1.02:

http://www.usb.org/developers/devclass_docs/pos1_02.pdf

B.2. Hardware

The scale communication to the PC host is via a standard USB interface cable with a A connector and B connector. This cable will connect to a Series B type receptacle on the scale and the Series A type receptacle on the PC.

B.3. Electrical Connection

The scale supports one USB interface. Refer to Universal Serial Bus Specification Revision 2.0 for details on signal termination, signal levels and other electrical specifications for the USB interface.

B.4. Power

The PS scale can be considered bus-powered as a low power device because it consumes less than 1 unit load of power (<100ma) with up to two non-backlit displays connected. It does not fully comply with the USB specifications because it does not support the “suspend state”.

B.5. Protocol

This interface supports the standard Universal Serial Bus HID Point of Sale Usage Tables for scales. Refer to the Universal Serial Bus HID Point of Sale Usages Tables document for details on this protocol.

METTLER TOLEDO has additional information to assist software developers to communicate to the PS scales by USB. Please request document **30126465, USB Protocol Specifications for BC Scales**, from your local METTLER TOLEDO representative or call 1-800-786-0812. In addition to the usage tables referenced above, this document includes the vendor extensions for full BC scale functionality.

C USB Virtual Serial Driver

This appendix covers

- Hardware
- Driver Installation

The Virtual Serial Driver allows the BC scale to communicate serially over a USB cable connection. This driver allows the scale to communicate serially with PC's that do not have a serial DB9 connection. The programming of the Virtual Serial capability is explained in Chapter 4.

C.1. Hardware

The scale communication to the PC host is via a standard USB interface cable with a A connector and B connector. This cable will connect to a Series B type receptacle on the scale and the Series A type receptacle on the PC.

An external USB/Serial adapter is **not** needed for communication.

- Note: If a serial cable was supplied with the scale, please retain for future use in case the scale software version needs to be updated.

The VIRTUAL DRIVER can communicate scale weight to the PC, but it cannot be used to download new scale firmware. The scale serial port must be used to download scale firmware.

An external USB/Serial adapter (like Keyspan USA-19HS) utilizes the scale serial port and can be used for PC's that do not have a serial connection.

C.2. Driver Installation

The software program required to enable the virtual serial capability of the BC scale is called the Mettler Toledo Virtual Serial Port Installer, and it can be downloaded from the Mettler Toledo website at:

- www.mt.com/ind-BCscale

Go to the **Download** tab, select Virtual Driver, and download to a folder on the local PC.

Once downloaded, open the **setup.exe** file on the PC.

Name	Date modified	Type	Size
GSP Virtual Serial Port	2013-09-09 9:31 AM	File folder	
dpinst.xml	2013-09-06 3:44 PM	XML Document	2 KB
setup.exe	2012-06-02 7:52 AM	Application	533 KB

C.2.1. Installation

1. With the BC scale unplugged from the USB port, double-click the setup.exe file in the driver installation directory.



2. Click **Next >** to begin the installation. The installer will install the drivers to the preconfigured driver's directory on the computer.

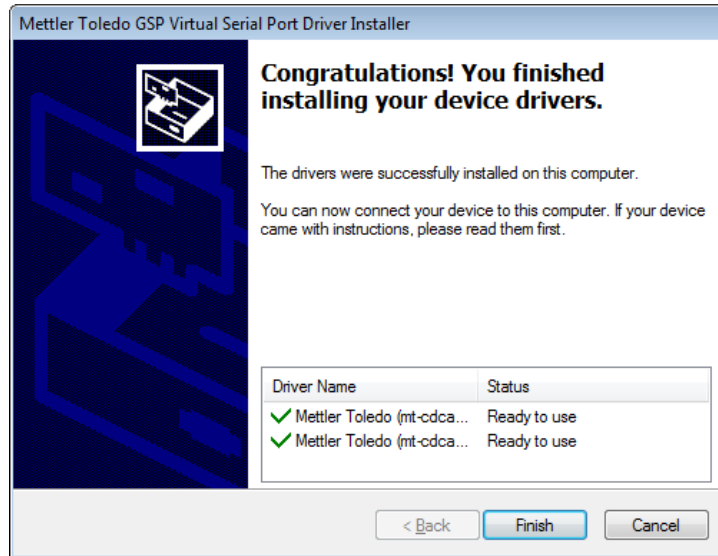

3. When the installation is complete, press the "Finish" button and plug in the GSP.

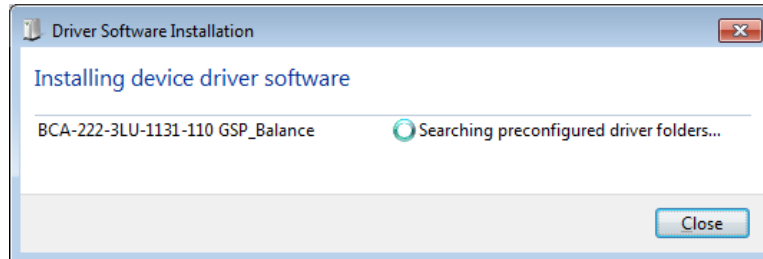
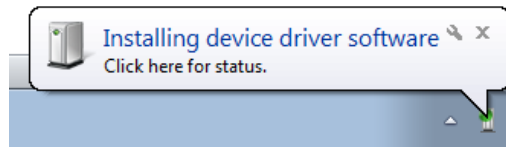

4. Windows will search the preconfigured driver's folder to find the GSP driver.

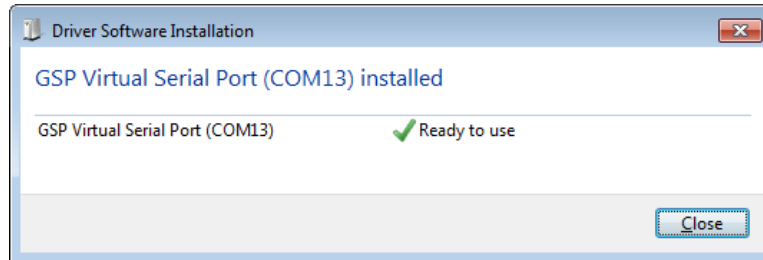

5. When the search and configuration is complete, the BC scale Virtual Serial Port is ready to use. In this case, the BC scale has been configured to use COM13. This COM port should be used by any software that wishes to communicate with the scale.
 - Note: The COM port selected may vary from system to system.

D Host Interface for Setup

This appendix covers

- Software Application
- Driver Installation

The Host Interface for Setup is not included in the current version of the BC scale.

D.1. Software Application

N/A

D.2. Driver Installation

The BC scale software driver can be downloaded. Program is called **METTLER TOLEDO Virtual Serial Port Installer**. This driver can be downloaded from the METTLER TOLEDO website at.

www.mt.com/ind-BCscale

Go to the **Download** tab, select Virtual Driver, and download to a folder on the local PC.

E Special Configuration

E.1. Software Application

E.2. Driver Installation

The BC scale software driver can be downloaded. Program is called **METTLER TOLEDO Virtual Serial Port Installer**. This driver can be downloaded from the METTLER TOLEDO website at.

www.mt.com/ind-BCscale

Go to the **Download** tab, select **Virtual Driver**, and download to a folder on the local PC.

E.3. Price Command

E.4. Logo Command

E.5. Custom Message Command

F GEOCAL Codes

GeoCal® Location Codes					
State	Code	State	Code	State	Code
Alabama		Indiana		North Carolina	
Birmingham & North	13	North of Indianapolis	16	Raleigh & North	14
South of Birmingham	12	Indianapolis & South	15	South of Raleigh	13
Alaska		Iowa		North Dakota	18
Anchorage & South	23	North of Des Moines	17	Ohio	
Anchorage – Kotzebue	26	Des Moines & South	16	Akron & North	16
North of Kotzebue	27	Kansas	14	South of Akron	15
Arizona		Kentucky	14	Oklahoma	13
Phoenix & North	12	Louisiana	12	Oregon	
South of Phoenix	11	Maine	18	Salem & North	18
Arkansas	13	Maryland	15	Salem - Oakridge	17
California		Massachusetts	17	South of Oakridge	16
North of Chico	16	Michigan		Pennsylvania	16
Chico – San Francisco	15	NW of Lake Michigan	18	Rhode Island	16
San Fran. - Bakersfield	14	SE of Lake Michigan	17	South Carolina	13
South of Bakersfield	13	Minnesota	18	South Dakota	17
Colorado		Mississippi		Tennessee	13
Denver & North	13	Kosciusko & North	13	Texas	
South of Denver	12	South of Kosciusko	12	NE of Colorado River	12
Connecticut	16	Missouri		SW of Colorado River	11
Delaware	15	North of Springfield	15	Utah	13
Florida		Springfield & South	14	Vermont	17
West Palm Beach & North	11	Montana		Virginia	14
South of West Palm Beach	10	Helena & North	18	Washington, DC	15
Georgia	12	South of Helena	17	Washington State	18
Hawaii	9	Nebraska	15	West Virginia	15
Idaho		Nevada	13	Wisconsin	
North of Salmon River Mt.	17	New Hampshire	17	Green Bay & North	18
South of Salmon River Mt.	16	New Jersey	16	South of Green Bay	17
Illinois		New Mexico	11	Wyoming	
Bloomington & North	16	New York		North of Casper	15
South of Bloomington	15	Albany & North	17	Casper & South	14
		South of Albany	16		

METTLER TOLEDO Service

To protect your METTLER TOLEDO product's future:

Congratulations on choosing the quality and precision of METTLER TOLEDO. Proper use according to these instructions and regular calibration and maintenance by our factory-trained service team ensure dependable and accurate operation, protecting your investment. Contact us about a METTLER TOLEDO service agreement tailored to your needs and budget.

We invite you to register your product at www.mt.com/productregistration so we can contact you about enhancements, updates and important notifications concerning your product.

www.mt.com/IND-BC-scale

For more information

Mettler-Toledo, LLC

1900 Polaris Parkway
Columbus, OH 43240
Phone 800 438 4511
Fax 614 438 4900

© 2014 Mettler-Toledo, LLC
30126862 Rev. 00, 04/2014
Document version -



12345678